

# Heavy Vehicle Local Road Report Parramatta



<b>Project Name:</b>	Sydney Metro West		
<b>Client Name:</b>	Sydney Metro		
<b>Project Address:</b>	DELTA will be working at the following sites: 1. Parramatta 2. Clyde 3. Westmead		
<b>Project Description/Scope:</b>	DELTA Pty Ltd (DELTA) is responsible for the demolition of existing structures including removal of all hazardous materials and utility works of the Sydney Metro West Project at Clyde, Parramatta and Westmead		
<b>Prepared By:</b>	Name: 	Signature: 	Date: 7 <sup>th</sup> October 2021
<b>Reviewed By:</b>	Name: 	Signature: 	Date: 7 <sup>th</sup> October 2021
<b>Authorised By (Project Director):</b>	Name: 	Signature: 	Date: 7 <sup>th</sup> October 2021

# CONTENTS

CONTENTS.....	2
1 GLOSSARY/ ABBREVIATIONS .....	3
2 AUTHORISATION AND CONTROL.....	4
2.1 Authorisation .....	4
2.2 Distribution .....	4
2.3 Revision .....	4
3 EXECUTIVE SUMMARY.....	5
4 INTRODUCTION .....	6
4.1 Background .....	6
4.2 Purpose .....	7
4.3 Scope.....	7
4.3.1 <i>Minister’s Conditions of Approval and Revised Environmental Mitigation Measures</i> .....	7
4.4 Objectives .....	7
5 LEGAL AND OTHER REQUIREMENTS .....	11
5.1 Legislation .....	11
5.2 Guidelines and Other Documents.....	11
6 EXISTING ENVIRONMENT .....	12
6.1 Locality .....	12
6.2 Existing conditions .....	13
6.2.1 <i>George Street</i> .....	13
6.3 Land use .....	15
6.4 Performance Based Standard Network .....	15
7 PROJECT WORKS.....	17
7.1 Construction vehicles and plant.....	17
7.1.1 <i>Typical movements</i> .....	17
7.1.2 <i>Known sensitive receivers</i> .....	19
8 FLEET MANAGEMENT.....	20
8.1 EIS Haulage routes .....	20
8.2 Concurrent construction works and traffic arrangements .....	22
8.2.1 <i>Holdmark</i> .....	22
8.2.2 <i>Parramatta Light Rail</i> .....	23
8.3 Proposed heavy vehicle routes and management.....	24
8.3.1 <i>Site management</i> .....	27
8.3.2 <i>Road dilapidation report</i> .....	28
8.4 Cumulative impacts.....	28
8.4.1 <i>Traffic Control Group (TCG)</i> .....	28
8.4.2 <i>Traffic and Transport Liaison Group (TTLG)</i> .....	28
9 SAFETY .....	29
10 CONSULTATION AND COMMUNICATION.....	30
10.1 Stakeholders consulted.....	30
10.2 Induction .....	31
10.3 Toolbox talks .....	31
APPENDICES.....	32
A. Received comments.....	32
B. Swept path analysis and legislation .....	33
C. Written advice.....	34
D. Road Dilapidation Report Transmittal .....	35

# 1 GLOSSARY/ ABBREVIATIONS

Term/ abbreviation	Definition
CoPC	City of Parramatta Council
CJP	Customer Journey Planning
CPAS	Construction Parking and Access Strategy
CTMF	Construction Traffic Management Framework (by TfNSW)
CTMP	Construction Traffic Management Plan (site specific)
Local road	Any road that is not defined as a classified road under the <i>Roads Act 1993</i> (NSW)
MCoA	Ministerial Conditions of Approval
REMM	Revised Environmental Management Measure(s)
ROL	Road Occupancy License
Sensitive land use(s)	Includes residences, educational institutions, (including preschools, schools, universities, TAFE colleges), health care facilities, (including nursing homes and hospitals), religious facilities (including churches), child care centres and passive recreation areas (including outdoor ground used for teaching). Receivers that may be considered to be sensitive include commercial premises (including film and television studios, research facilities, entertainment spaces, temporary accommodation such as caravan parks and camping grounds, restaurants, office premises and retail spaces) and industrial premises as identified by the Planning Secretary.
TCG	Traffic Control Group
TCP	Traffic Control Plan – superseded by TGS
TfNSW	Transport for NSW
TGS	Traffic Guidance Scheme (formerly TCP)
TTLG	Traffic and Transport Liaison Group

## 2 AUTHORISATION AND CONTROL

### 2.1 Authorisation

This Plan is authorised by the Project Director. All project personnel are to ensure that their work activities and those of Project Consultants, Contractors and Suppliers are carried out in accordance with the requirements of this Plan.

### 2.2 Distribution

This Plan is a Controlled Document and must be distributed and revised under the guidance of the Project Manager. People who hold Controlled copies are responsible for maintaining their copies up-to-date.

### 2.3 Revision

The Project Director will monitor the implementation of this Plan and review the need for change or improvements having due regard to:

- Change in work scope, client comments etc.
- Internal and external audits
- Suggestions and comments from project personnel
- Incidence and frequency of non-conformance
- Necessity for corrective or preventative action
- Legal Update and Requirements
- Review by Delta Groups Management team
- Annual Review

All changes must be formally approved by the Project Director. Changes to the recent revision will be highlighted.

The following table provides a record of amendments made to this document.

Rev	Date	Description	Page	Developed By	Approved By
0	1/09/2021	Initial Submission	All	S [REDACTED]	[REDACTED]
1	20/09/2021	Resubmission based on comments received	All	S [REDACTED]	[REDACTED]
2	22/09/2021	Resubmission based on comments received	All	S [REDACTED]	[REDACTED]
3	7/10/2021	Resubmission based on comments received 29 Sept and 1 October 2021	All	S [REDACTED]	[REDACTED]
<b>Distribution Register</b>					
Rev No.	Date of Issue	Name of Recipient	Position / Organisation		
0	1/09/2021	[REDACTED]	Principal's Representative Project Manager		
1	20/09/2021	[REDACTED]	Principal's Representative Project Manager		
2	22/09/2021	[REDACTED]	Principal's Representative Project Manager		
3	7/10/2021	[REDACTED]	<b>Principal's Representative Project Manager</b>		
		[REDACTED]			

### 3 EXECUTIVE SUMMARY

This Heavy Vehicle Local Road report (HVLRL) has been developed to address the requirements of the Ministerial Conditions of Approval related to the Critical State Significant Infrastructure of Sydney Metro West.

The HVLRL identifies the heavy vehicle routes into the site not identified in the Environmental Impact Statement, the road classification and the suitability of the routes based on swept path analysis and adjacent land uses.

For the Parramatta site, the routes proposed into site are via Wilde Avenue (existing EIS route), Phillip Street, Charles Street and George Street (existing EIS route) which are all local roads under the care and control of the City of Parramatta Council. The suitability of these routes has been assessed based on typical Heavy Vehicle sizes, eg: truck and dog combination and 12.5m Single Unit trucks. The swept paths show that all vehicle types operate satisfactorily.

Footpaths are provided on all streets within the Parramatta CBD and signalised pedestrian crossings exist at all major east west/ north south crossing points. Pedestrian access within Horwood Place will be provided for tenants of the retained Church Street properties – this path will be delineated by hoarding. No other pedestrian access is provided for on Horwood Place.

The use of Performance Based Standard vehicles will not be used at this site.

## 4 INTRODUCTION

### 4.1 Background

The Sydney Metro is Australia’s biggest public transport program comprising four main packages of works. The Sydney Metro West (SMW) package is a critical part of this overall program extending from Westmead to The Bays site in Rozelle. The package aims to:

- Provide faster more reliable public transport options between greater Parramatta and the Sydney CBD
- Double the existing rail capacity between Parramatta and Sydney CBDs
- Support growing residential and employment zones between Westmead and The Bays and
- Allow for better public transport transfers between rail lines

The project includes:

- Approximately 24-kilometres of twin tunnels between Westmead and the Sydney CBD
- New metro stations at Westmead, Parramatta, Sydney Olympic Park, North Strathfield, Burwood North, Five Dock, The Bays and Sydney CBD
- A turn-up-and-go metro service operating between Westmead and Sydney CBD.
- The approved Stage 1 construction works includes:
  - Tunnel excavation including tunnel support activities between Westmead and The Bays
  - Station excavation for new stations at Westmead, Parramatta, Sydney Olympic Park, North Strathfield, Burwood North, Five Dock and The Bays
  - Shaft excavation for services facilities at Rosehill, Silverwater and between Five Dock and The Bays
  - Civil work for a stabling and maintenance facility at Clyde
  - A concrete segment facility for use during tunnelling located at Clyde
  - Excavation of a tunnel dive structure and associated tunnels at Rosehill to support a connection between the Clyde facility and the mainline metro tunnels.

The proposed Sydney Metro West alignment and the locations of proposed stations and operational ancillary infrastructure are shown in Figure 1 below.

Sydney Metro has engaged DELTA Group to undertake the demolition works at three sites associated with the Sydney Metro West project, specifically at Clyde, Parramatta and Westmead.

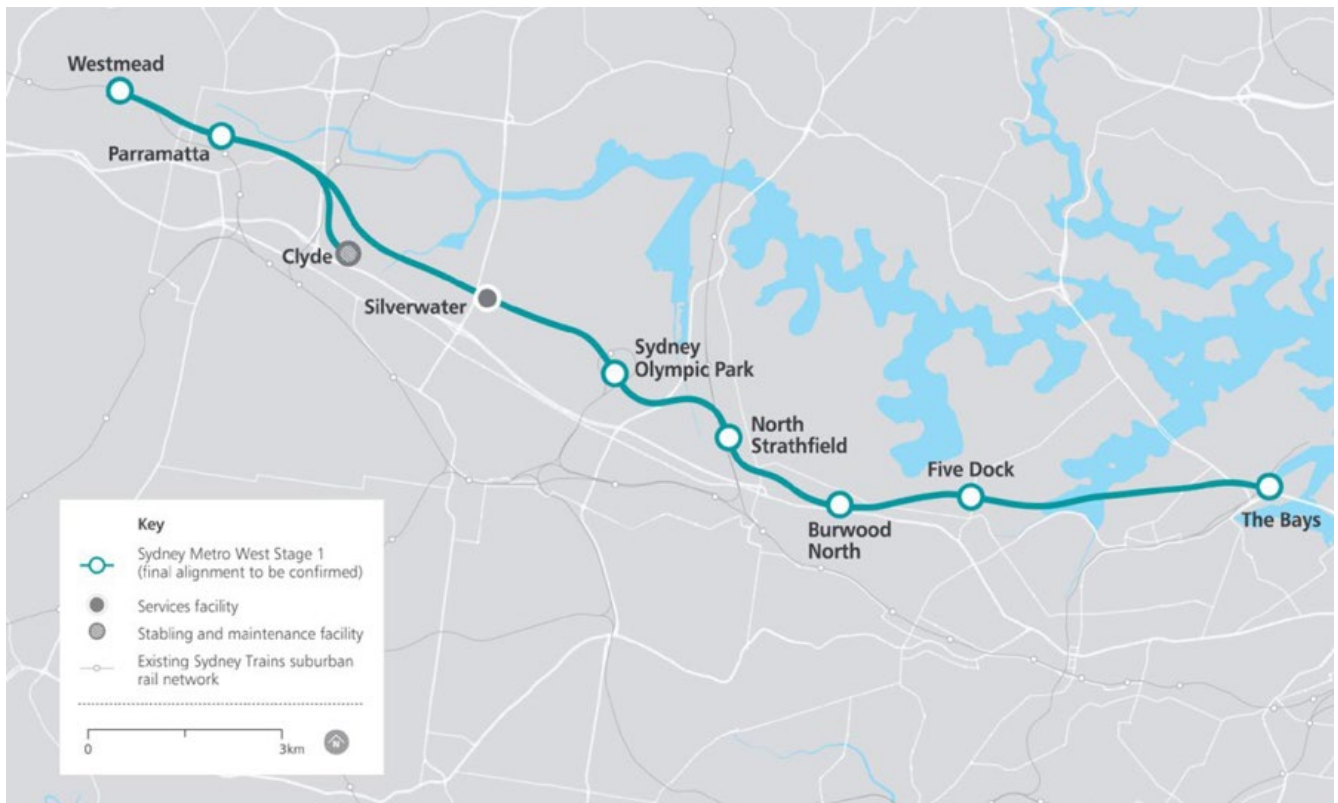

## 4.2 Purpose

The purpose of this document is to define the project requirements for the use of local roads for heavy vehicles (HV) that have not been identified and assessed in:

- Sydney Metro West – Westmead to The Bays and Sydney CBD Environmental Impact Statement dated 15 April 2020
- Sydney Metro West – Westmead to The Bays and Sydney CBD Submissions Report dated 20 November 2020
- Sydney Metro West – Westmead to The Bays and Sydney CBD Amendment Report dated 20 November 2020

This document is used to identify and assesses the HV routes required for the Parramatta site for demolition works.

## 4.3 Scope

### 4.3.1 Minister's Conditions of Approval and Revised Environmental Mitigation Measures

DELTA notes that the Project must be carried out generally in accordance with the description provided in the Environmental Impact Statement (EIS) as amended by the Sydney Metro West Westmead to The Bays and Sydney CBD – Amendment Report Concept and Stage 1 2020, and the CSSI Ministerial Conditions of Approval (MCoA) and Revised Environmental Management Measures (REMMs) detailed in Table 1 and Table 2, below

The content of this Heavy Vehicle Local Road (HVLR) report has been prepared to comply with MCoA D86 and D87 and applies to all works to be undertaken for the demolition works at the Parramatta site only. Separate HVLR have been provided for the Clyde and Westmead sites.

## 4.4 Objectives

DELTA's traffic objectives for the Project are:

- To minimise our impacts on traffic and road users
- To avoid accidents and minimise potential road safety risks
- Minimise changes to the road and path network



**Table 1: Ministerial Conditions of Approval requirements for HVLR**

Requirement	Detail	Where addressed
MCoA D86	Local roads proposed to be used by Heavy Vehicles to directly access construction sites that are not identified in the documents listed in Condition A1 of this scheduled must be approved by the Planning Secretary and be included in the CTMPs	This document
MCoA D87	All requests to the Planning Secretary for approval to use local roads under Condition D86 above must include the following:	Section 7.1
	a) A swept path analysis	Appendix B
	b) Demonstration that the use of local roads by Heavy Vehicles for the CSSI will not compromise the safety of pedestrians and cyclists of the safety of two way traffic flow on two way roadways	Sections 6.1, 8.3, 9 and Appendix B
	c) Details as to the date of completion of the road dilapidation surveys for the subject local roads and	Section 8.3.2
	d) Measures that will be implemented to avoid where practicable the use of local roads past schools, aged care facilities childcare facilities during their peak operation times	Section 7.1.2
e) Written advice from an appropriately qualified professional on the suitability of the proposed Heavy Vehicle route which takes into consideration items (a) to (d)	Appendix C	

**Table 2: Revised Environmental Management Measures**

Requirement	Impact/ Issue	Mitigation Measure	Where addressed
TT6	Road Safety	All trucks would enter and exit construction sites in a forward direction, where feasible and reasonable	Section 8
TT7	Congestion	Construction site traffic would be managed to minimise movements during peak periods	Section 8.3.1
TT8	Congestion	Construction site traffic immediately around construction sites would be managed to minimise vehicle movements through school zones during pick up and drop off times	Section 8
TT24	Cumulative construction traffic impacts	<p>Coordination and consultation with the following stakeholders would occur, where required, to manage the interface of projects under construction at the same time:</p> <ul style="list-style-type: none"> <li>• Transport for NSW including Transport Coordination</li> <li>• Department of Planning, Industry and Environment</li> <li>• Sydney Trains</li> <li>• NSW Trains</li> <li>• Sydney Buses</li> <li>• Sydney Water</li> <li>• Port Authority of NSW</li> <li>• Sydney Motorways Corporation</li> <li>• Emergency service providers</li> <li>• Utility providers</li> <li>• Construction contractors</li> </ul> <p>Coordination and consultation with these stakeholders would include:</p> <ul style="list-style-type: none"> <li>• Provision of regular updates to the detailed construction program, construction sites and haul routes</li> <li>• Identification of key potential conflict points with other construction projects</li> <li>• Developing mitigation strategies in order to manage conflicts. Depending on the nature of the conflict this could involve:                             <ul style="list-style-type: none"> <li>○ Adjustments to the Sydney Metro construction program work activities or haul routes or adjustments to the program activities or haul routes of other construction projects</li> </ul> </li> </ul>	Sections 8.4 and 10



Requirement	Impact/ Issue	Mitigation Measure	Where addressed
		○ Coordination of traffic management arrangements between projects	

Note that all other allocated traffic, transport and parking MCoA and REMMs will be managed through the preparation and implementation of the Construction Traffic Management Plans prepared in accordance with MCOA D85, and in line with Sydney Metro's Construction Traffic Management Framework (CTMF) or the Construction Parking and Access Strategy.

## 5 LEGAL AND OTHER REQUIREMENTS

### 5.1 Legislation

Identified regulatory requirements are:

- An approved and valid Road Occupancy Licence (ROL) both Transport Management Centre and Cumberland Council
- An approved relevant Speed Zone Authorisation (SZA)
- Approved permits from City of Parramatta Council including Road Opening Permit (ROP) and Hoarding Permit, where required
  - Australian Road Rules form the basis for state and territory road rules.
  - Roads Act 1993 (NSW) sets out rights along a public road, establishes procedures for a public road and provides the classification of roads.

Legislation relevant to traffic management also includes the *Environmental Planning and Assessment Act 1979* (EP&A Act), under which the project approval was granted.

DELTA regularly reviews its legislative requirements in accordance with its Integrated Management System (IMS).

### 5.2 Guidelines and Other Documents

Guidelines, specifications, and policies relevant to traffic include:

- AUSTRROADS Cycling Aspects of AustRoads Guides, 2017
- AUSTRROADS Guide to Traffic Management, 2020 – Parts 1-13
- AUSTRROADS Guide to Road Design, 2009-2020 – Parts 1-8
- AUSTRROADS Guide to Road Safety, 2006-2019 – Parts 1-9
- AUSTRROADS Road Safety Audit Second Edition, 2019: Checklist 4. Pre-opening scheme audit.
- AUSTRROADS Road Safety Audit Second Edition, 2019: Checklist 5: Roadwork traffic scheme audit.
- AUSTRROADS Road Safety Audit Second Edition, 2019: Checklist 6: Existing roads: road safety audit.
- Department of Infrastructure, Planning and Natural Resources Planning Guidelines for Walking and Cycling (2004)
- Roads & Traffic Authority NSW Guide to Traffic Generating Developments, 2002
- Roads & Traffic Authority NSW Bicycle Guidelines Version 1.2, 2005
- Roads and Maritime QA Specification G10 – Traffic Management, 2020.
- Roads and Maritime NSW Speed Zoning Guidelines, 2011.
- Roads and Maritime Traffic Control at Worksites Manual, 2020

## 6 EXISTING ENVIRONMENT

### 6.1 Locality

The site is located in the Central Business District (CBD) of the city of Parramatta and is bounded by Macquarie Street/Lane to the south, premises on Church Street to the west, George Street to the north and Macquarie Lane to the east, as shown on Figure 2, below.



**Figure 2: Parramatta site location (indicative site boundary only)**

Access to the State and Motorway network is available only from the local road network within Parramatta CBD and the regional road network outside of the CBD, as shown on Figure 3.

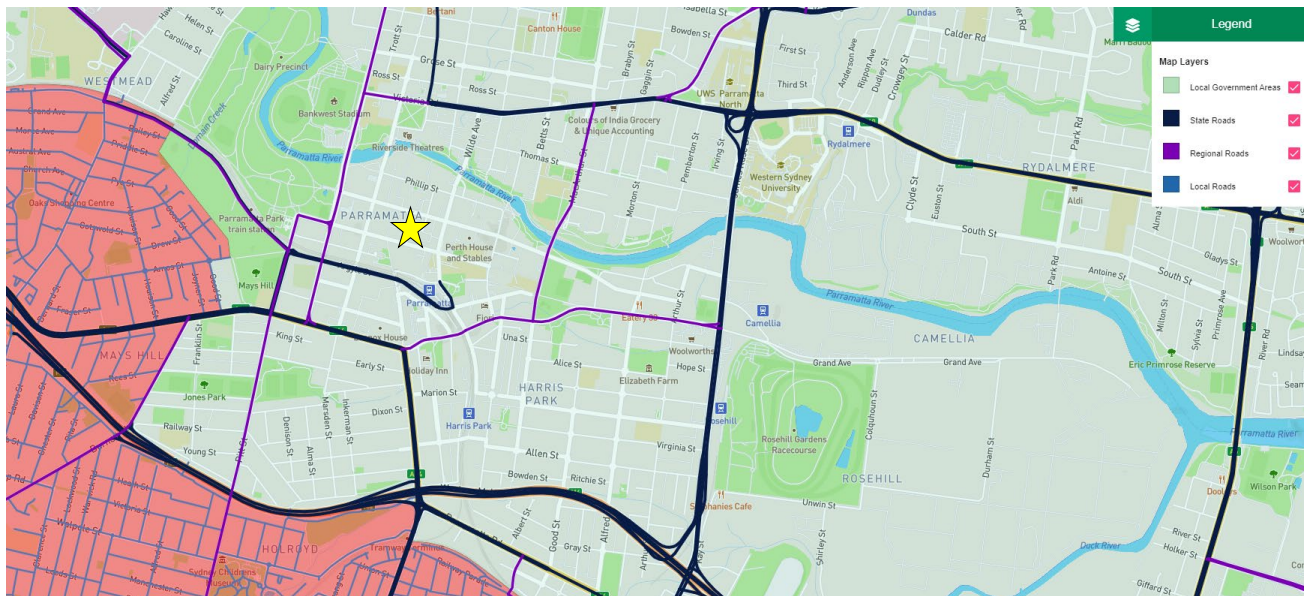

**Figure 3: NSW Road Classification (source: Road Network Classifications)**



## 6.2 Existing conditions

### 6.2.1 George Street

George Street is a local road under the care and control of City of Parramatta Council. George Street commences at O’Connell Street to the west and terminates at Arthur Street to the east. The speed limit is 40km/hr as are the majority of streets within the Parramatta CBD, as noted on Figure 4.

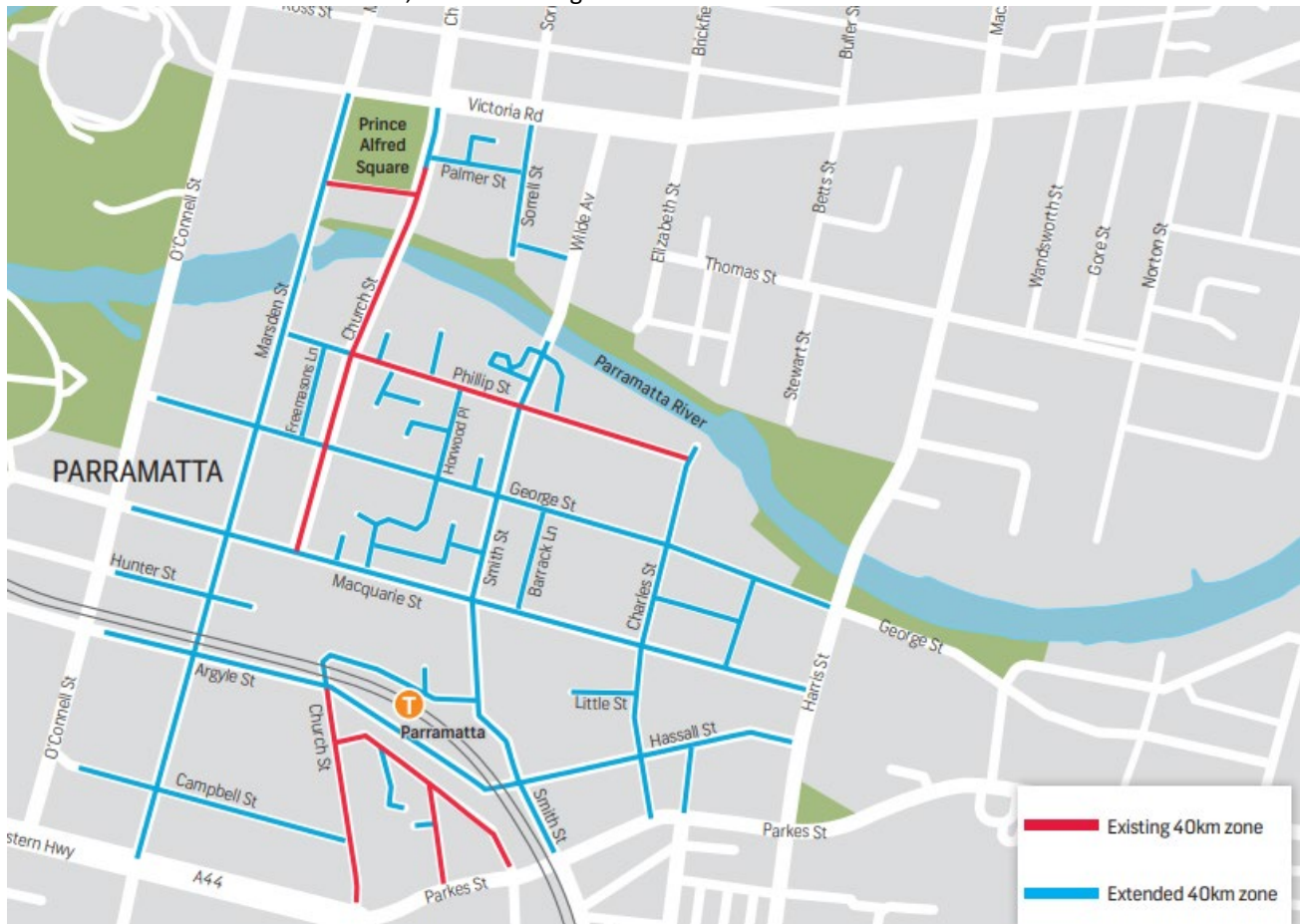

**Figure 4: Parramatta CBD 40km/hr speed restrictions area (source: City of Parramatta)**

This street is the main “high street” of Parramatta with a number of commercial properties located between Harris Street and Marsden Street, with the Justice precinct located at its western end between Marsden Street and O’Connell Street.

Traffic signals exist at a number of intersections along George Street including O’Connell Street, Marsden Street, Church Street, Smith Street, Charles Street and Harris Street. All traffic signals provide pedestrian crossing facilities. Footpaths are provided on both sides of George Street and George Street is noted as being a moderate difficult cycle route between Charles Street and Arthur Street, refer to Figure 5

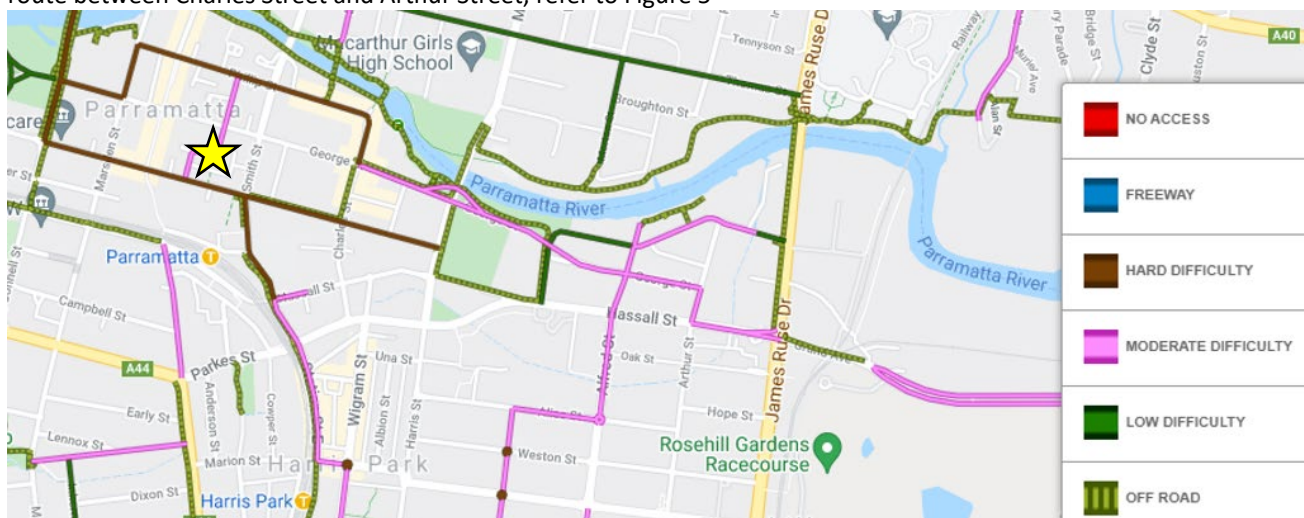

**Figure 5: Cycle paths/ routes within the Parramatta CBD**

Bus stops are located on George Street as shown on Figure 6, servicing route 900 – Parramatta Free Shuttle service.

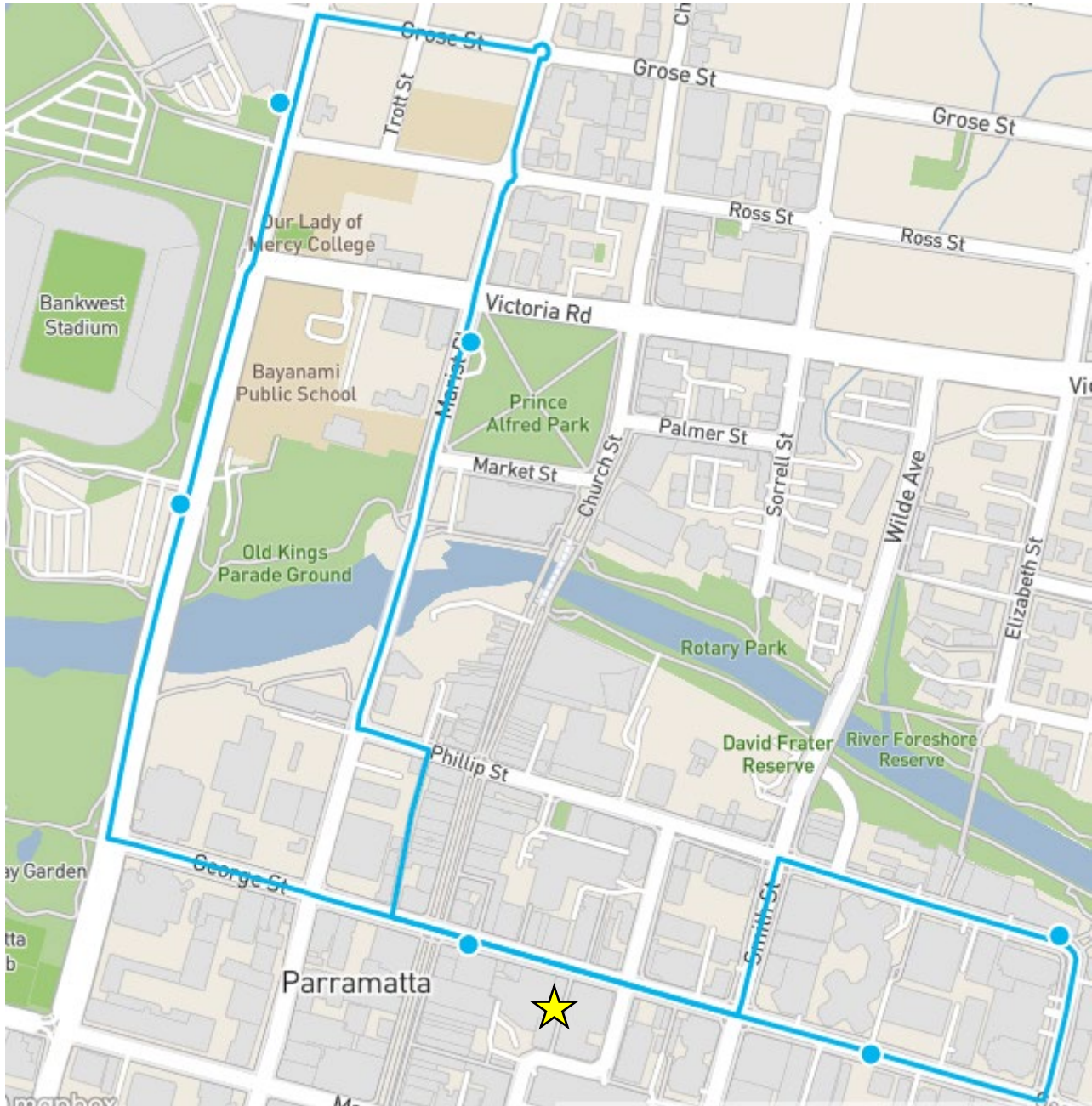

**Figure 6: Current bus stop locations**

Parking is time restricted around the site and generally within the Parramatta CBD. No Stopping restrictions exist at intersections and along streets which carry high traffic loads and/ or high number of public transport routes. Parking restrictions for the site and surrounds is shown on Figure 7

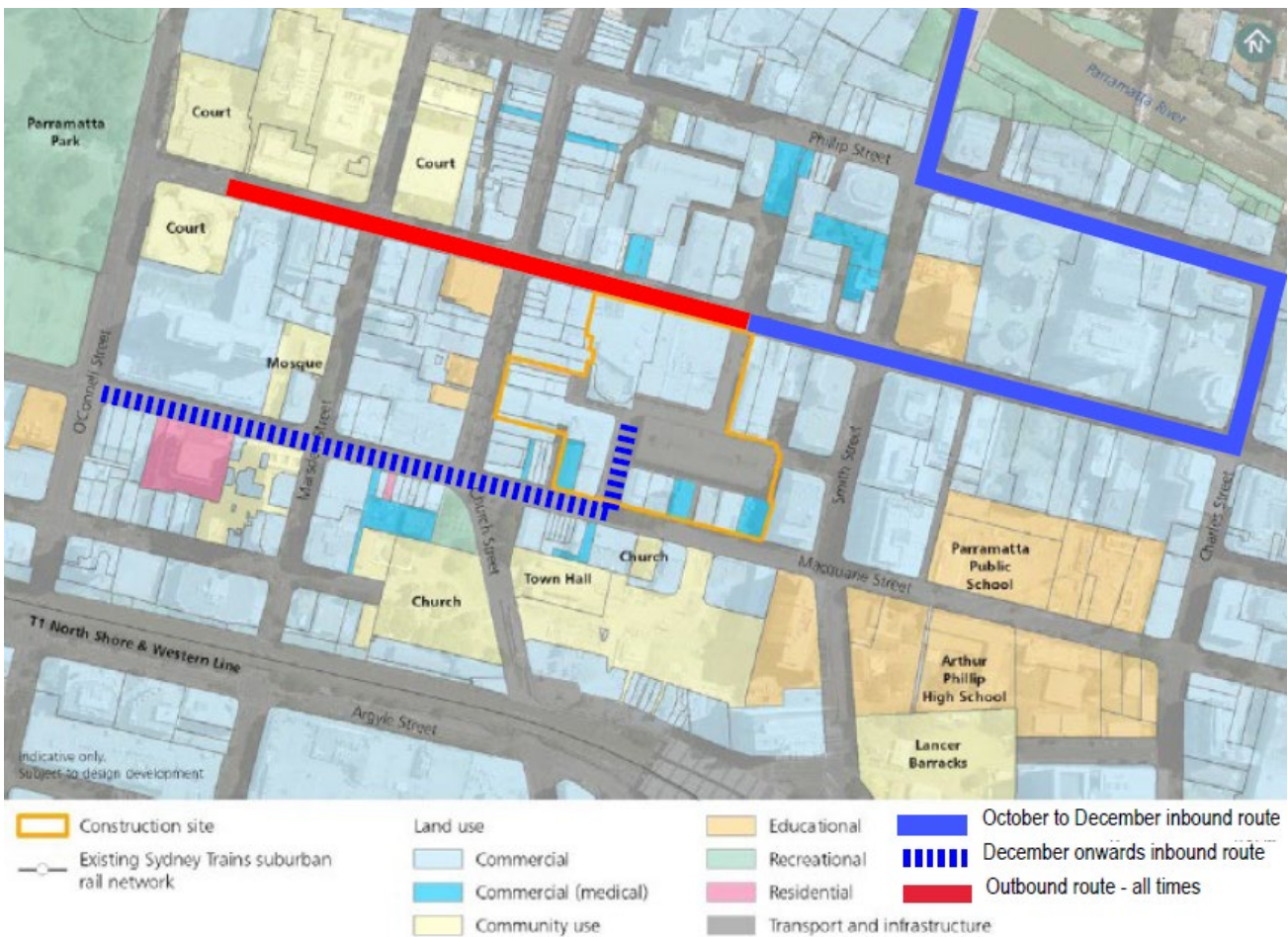



**Figure 7: Parking restrictions surrounding the site**

### 6.3 Land use

The site is located in the commercially zoned area, refer to Figure 8.



**Figure 8: Land use - Parramatta (source: Chapter 14 Property and Land Use EIS)**

### 6.4 Performance Based Standard Network

There are no PBS routes that allow access to the Parramatta site, as noted on Figure 9, below. This means that any use of PBS vehicles would require the Road Manager’s approval.



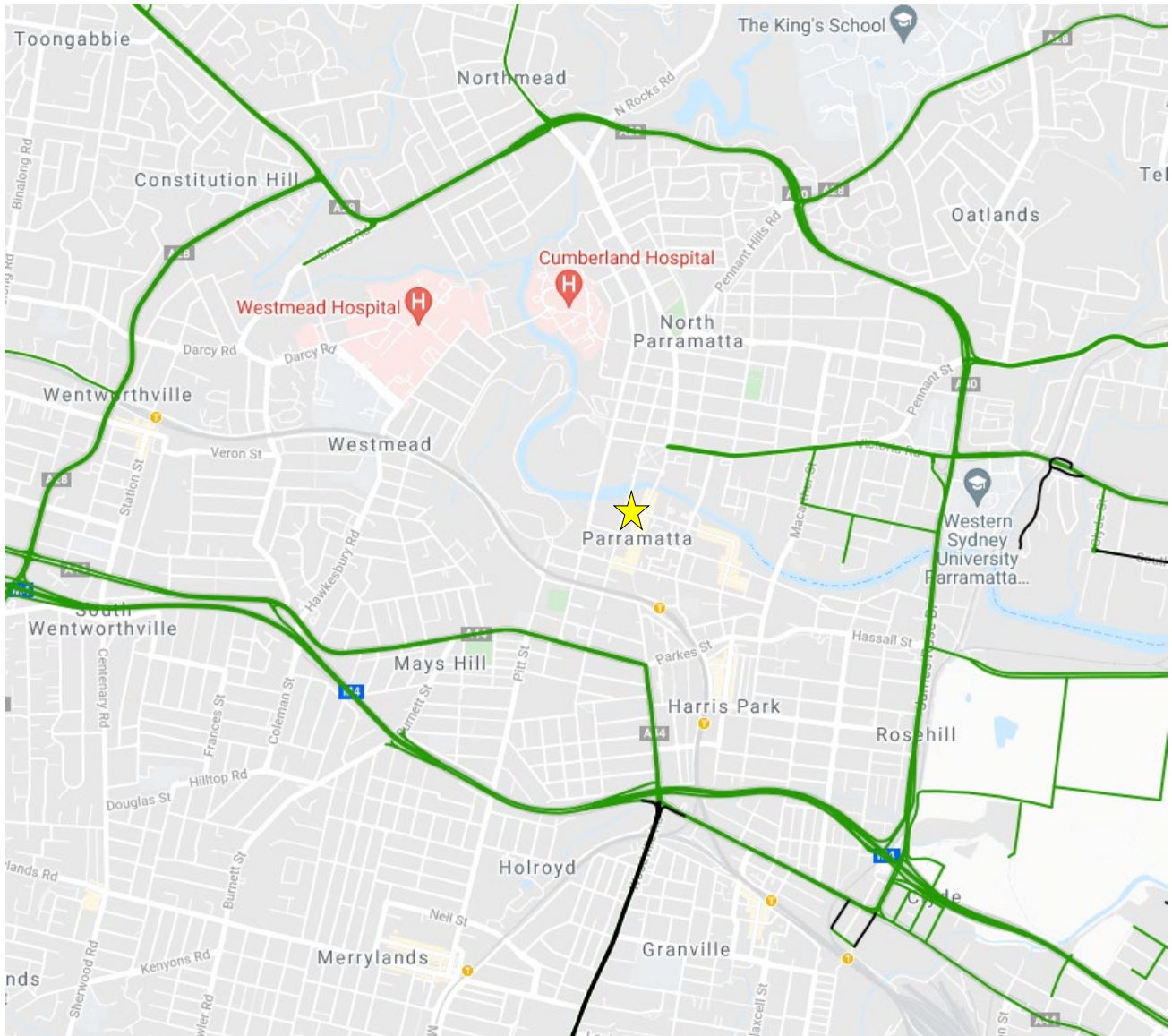

Figure 9: PBS Network (source: [TfNSW PBS](#))

## 7 PROJECT WORKS

The scope of works for the Parramatta site is as follows:

- Mobilisation and site set up
- Project planning, approvals and stakeholder management
- Service relocations and decommissioning
- Removal of existing substations
- Demolition of structures

Figure 10 provides the details of the works areas, whilst Table 3 provides the access dates

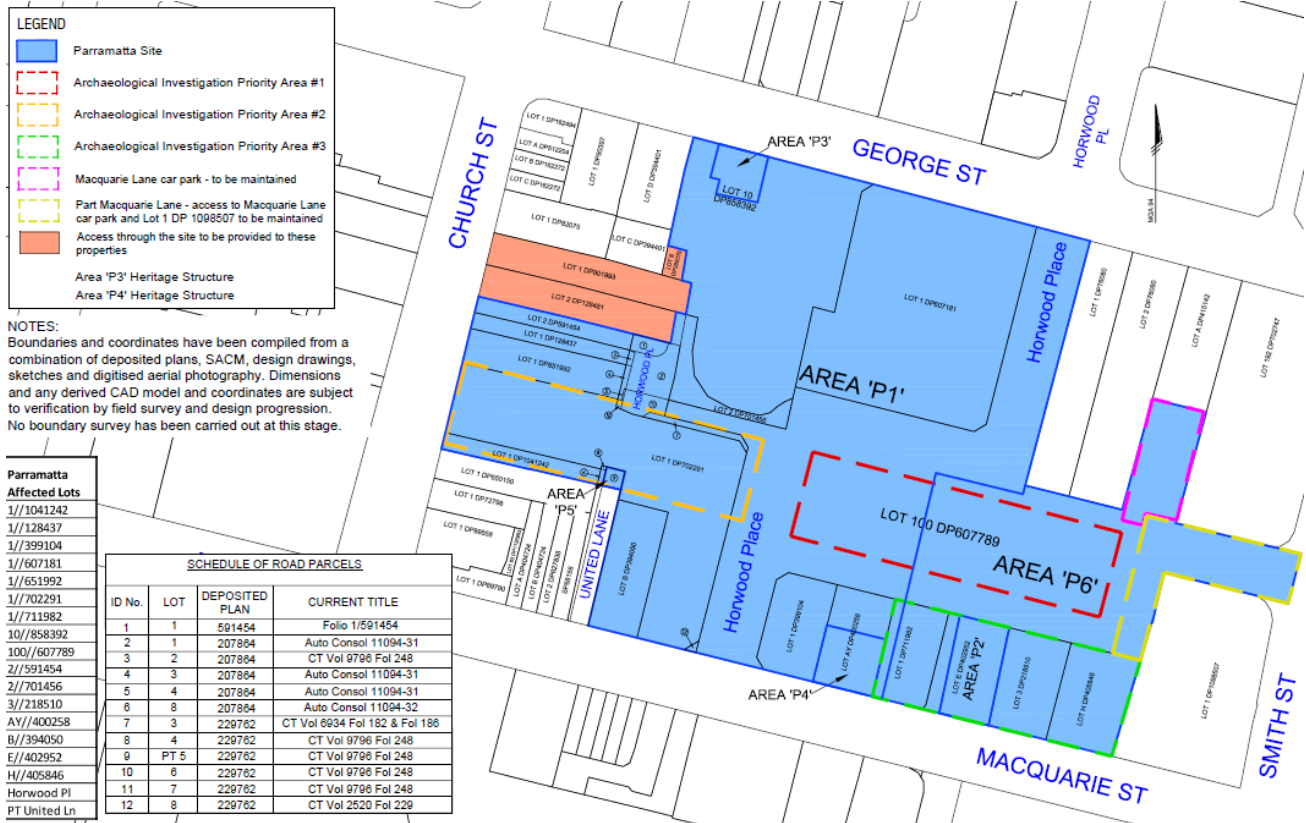

**Figure 10: Areas of work**

**Table 3: Site access schedule**

Area of the site	Site Access Date
Area P1	21 October 2021
Area P3	21 October 2021
Area P4	21 October 2021
Area P5	At a date nominated by the Principal with 4 weeks' notice
Area P6	21 October 2021

### 7.1 Construction vehicles and plant

The project works include demolition and utility works, requiring the use of Heavy Vehicles (HV) and large plant such as:

- Heavy Vehicles – rigid trucks, articulated trucks, crane trucks
- Excavators
- Mobile cranes – articulated and slewing

Note that no semi-trailers are required at this site and that all vehicles will be General Access vehicles. If oversize or over mass vehicles are required, then separate permits will be sought from the relevant authority(s).

#### 7.1.1 Typical movements

HV will transport materials from the work sites to authorised disposal sites. The number of vehicles is detailed in Table 4 and the EIS vehicle movements is also provided on Figure 11.

**Table 4: EIS and DELTA proposed HV movements**

Time	EIS heavy vehicles per hour	DELTA heavy vehicles per hour
0700-1000	4	4
1000-1500	11	11
1500-1800	4	4

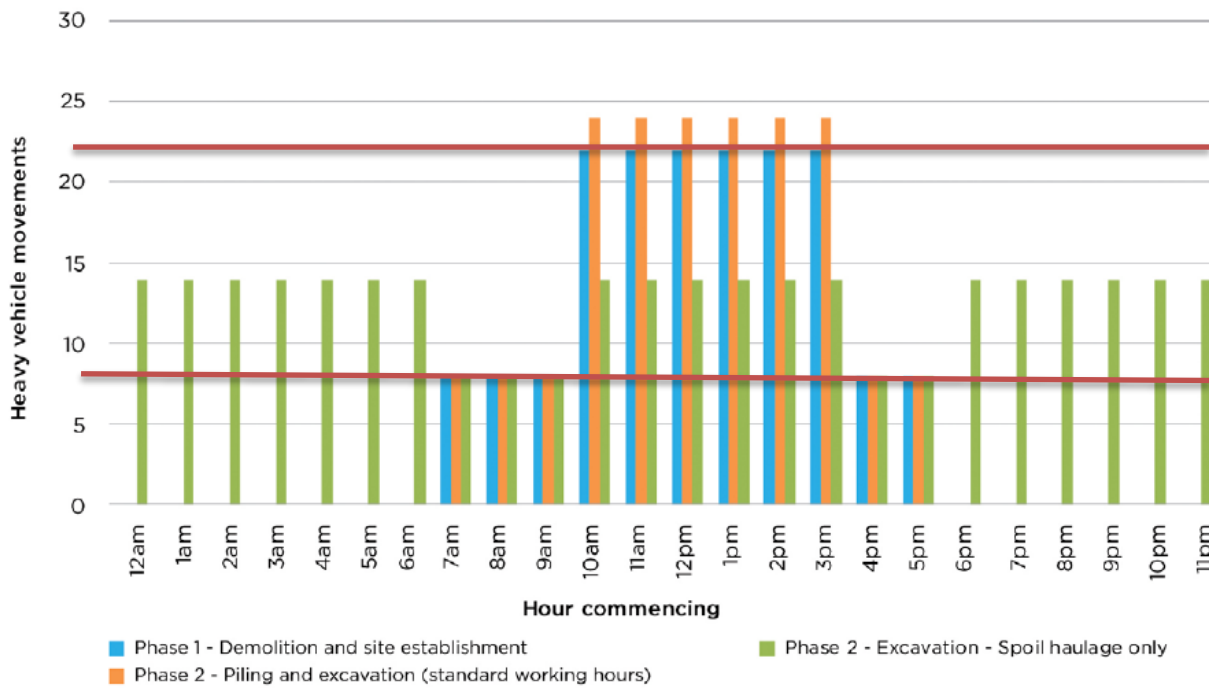

**Figure 11: EIS heavy vehicle movements**

### 7.1.2 Known sensitive receivers

A review of the existing sensitive receivers and their locations was undertaken by Sydney Metro during the EIS development phase of the project, with the results as noted on Figure 12 from the EIS. The proposed routes have been superimposed on this social infrastructure map to provide clarity on sensitive users that may be impacted. The outbound route is a nominated EIS route. The inbound route pre-Xmas is the only available route to the site given the current construction status of the Parramatta Light Rail works. The inbound route post-Christmas is the Sydney Metro nominated route.

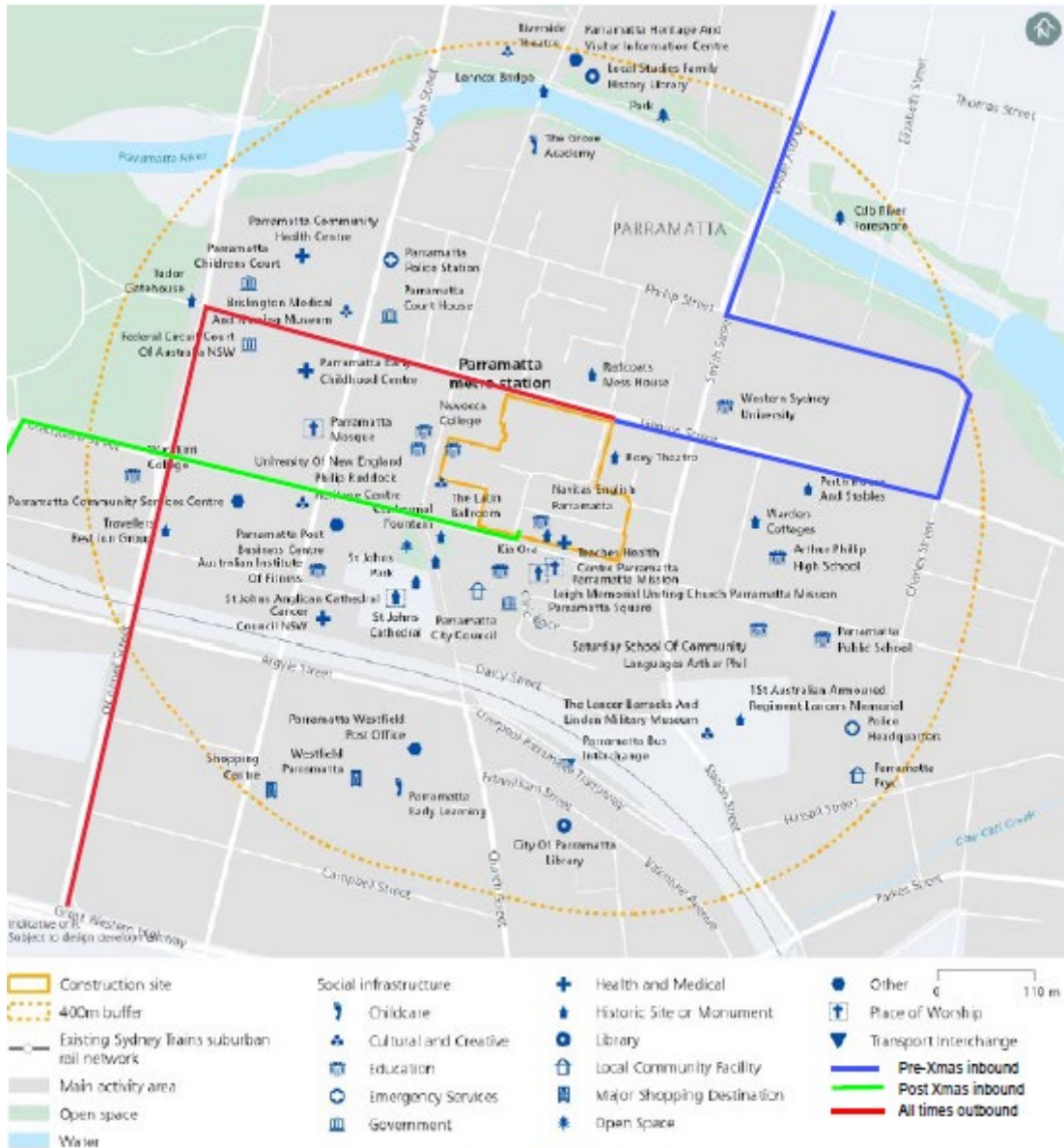

**Figure 12: Social infrastructure (Chapter 17 EIS) (indicative site boundary only)**



## 8 FLEET MANAGEMENT

Heavy vehicles are required to access the project work sites, which are located on the local road network within the Parramatta CBD. This section of the report provides details on the existing routes identified in the EIS documents and the scope of the routes subject to the Ministerial Conditions of Approval, specifically D87 and DELTA’s proposed site management.

### 8.1 EIS Haulage routes

The EIS nominated a number of routes into the Parramatta site, as noted on Figure 13.

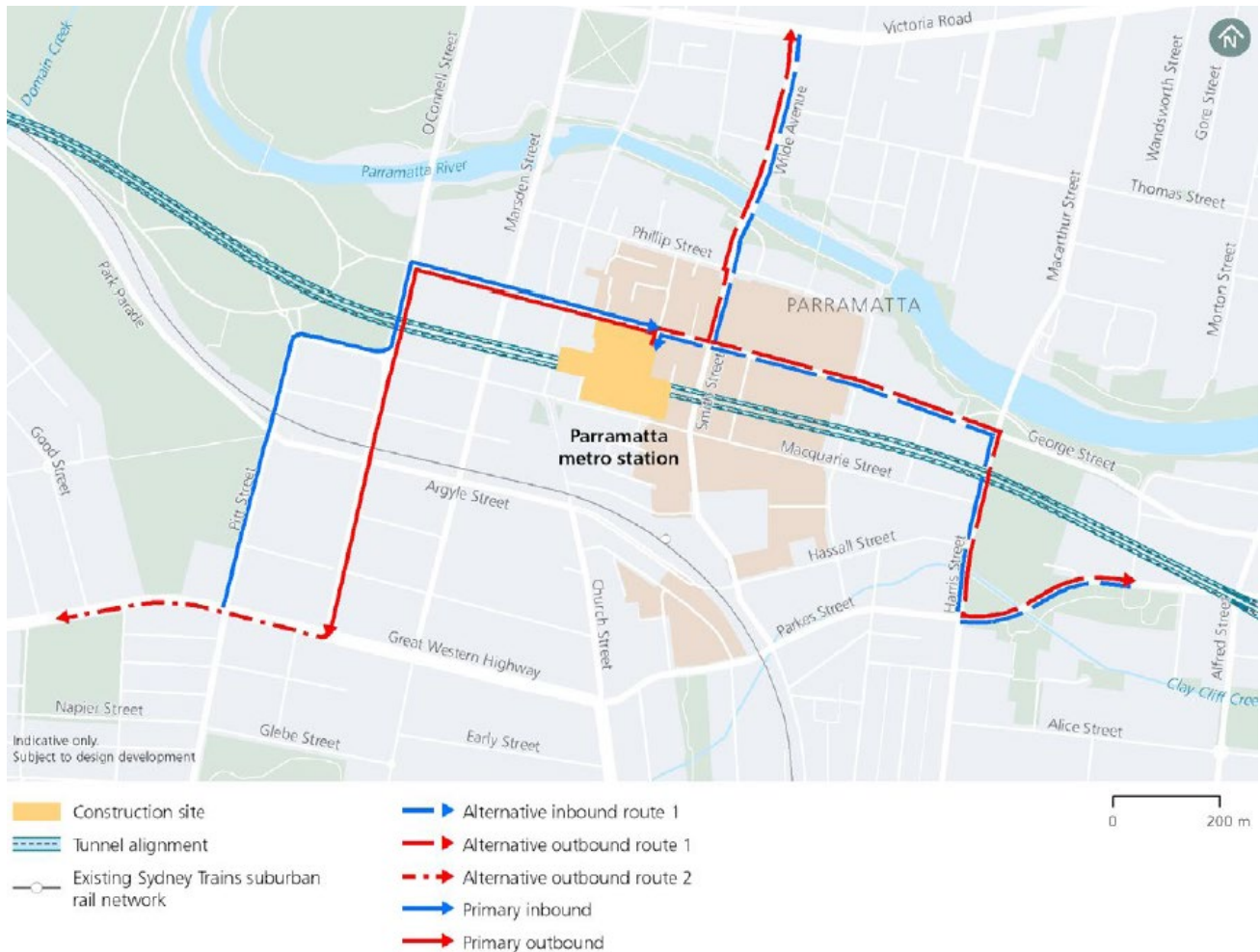

**Figure 13: EIS nominated haulage routes (indicative site boundary only)**

A review of the nominated haulage routes was undertaken given the current changes to the Parramatta CBD road network as part of the Parramatta Light Rail works. This review is detailed in Table 5 and is shown on Figure 14:

**Table 5: EIS route review**

EIS Route#	Route	Route restriction
Primary inbound	Pitt Street, turn onto Macquarie Street, left turn onto O’Connell Street, right turn onto George Street and right turn into Horwood Place	Right turn onto Horwood Place from George Street is banned
Alternative inbound route 1	Wilde Avenue, continue on Smith Street, right turn onto George Street, left turn onto Horwood Place	Right turn from Smith Street onto George Street is banned Left turn from George Street onto Horwood Place is banned for vehicle greater than 9m in length
Primary outbound	Left turn onto George Street from Horwood Place, left turn from George Street onto O’Connell Street	No restriction in place
Alternative outbound route 1	Right turn from Horwood Place onto George Street, right turn from George Street onto	Right turn from Horwood Place onto George Street is banned

EIS Route#	Route	Route restriction
	Harris Street, left turn from Harris Street onto Hassall Street	Right turn into Harris Street is not available due to road closure associated with Parramatta Light Rail works



**Figure 14: EIS route issues (indicative site boundary only)**

## 8.2 Concurrent construction works and traffic arrangements

In the area surrounding the site, a number of construction projects are being undertaken including Parramatta Light Rail and Holdmark.

### 8.2.1 Holdmark

Holdmark are working on the building at 85-97 Macquarie Street, seen on Figure 15. The building works are due for completion in January 2022 with fit out to commence post the completion of the building works. The current access/egress arrangements for Holdmark are shown on Figure 16 by two way traffic movements on Horwood Place. Post the changes to traffic arrangements, noted below and as detailed on Figure 17, access to their worksite will be via Macquarie Street eastbound and egress via Horwood Place onto George Street.

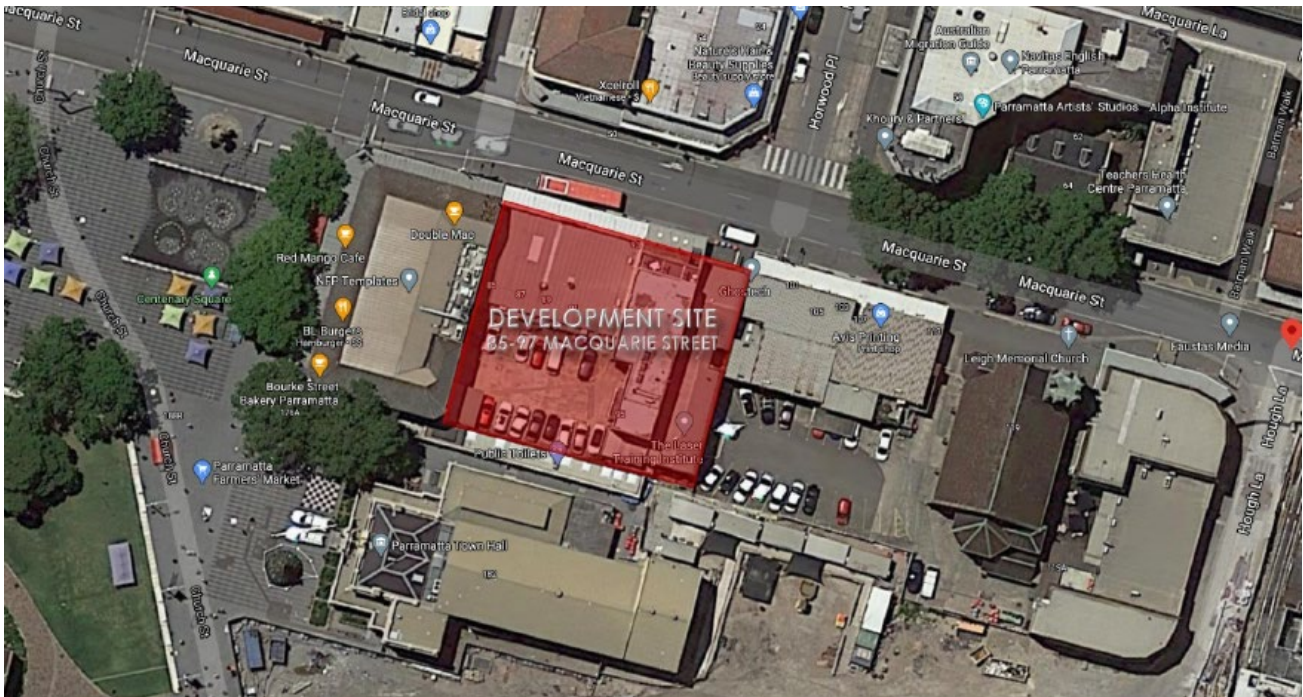

**Figure 15: Holdmark development site Parramatta**



### 8.2.2 Parramatta Light Rail

The current program of works for the Parramatta Light Rail shows that mid-September 2021 until Christmas, access into and out of Macquarie Street will not be possible due to construction works. Access to Macquarie Street is only available from Horwood Place which will be required to maintain two way traffic flow from George Street, refer to Figure 16.

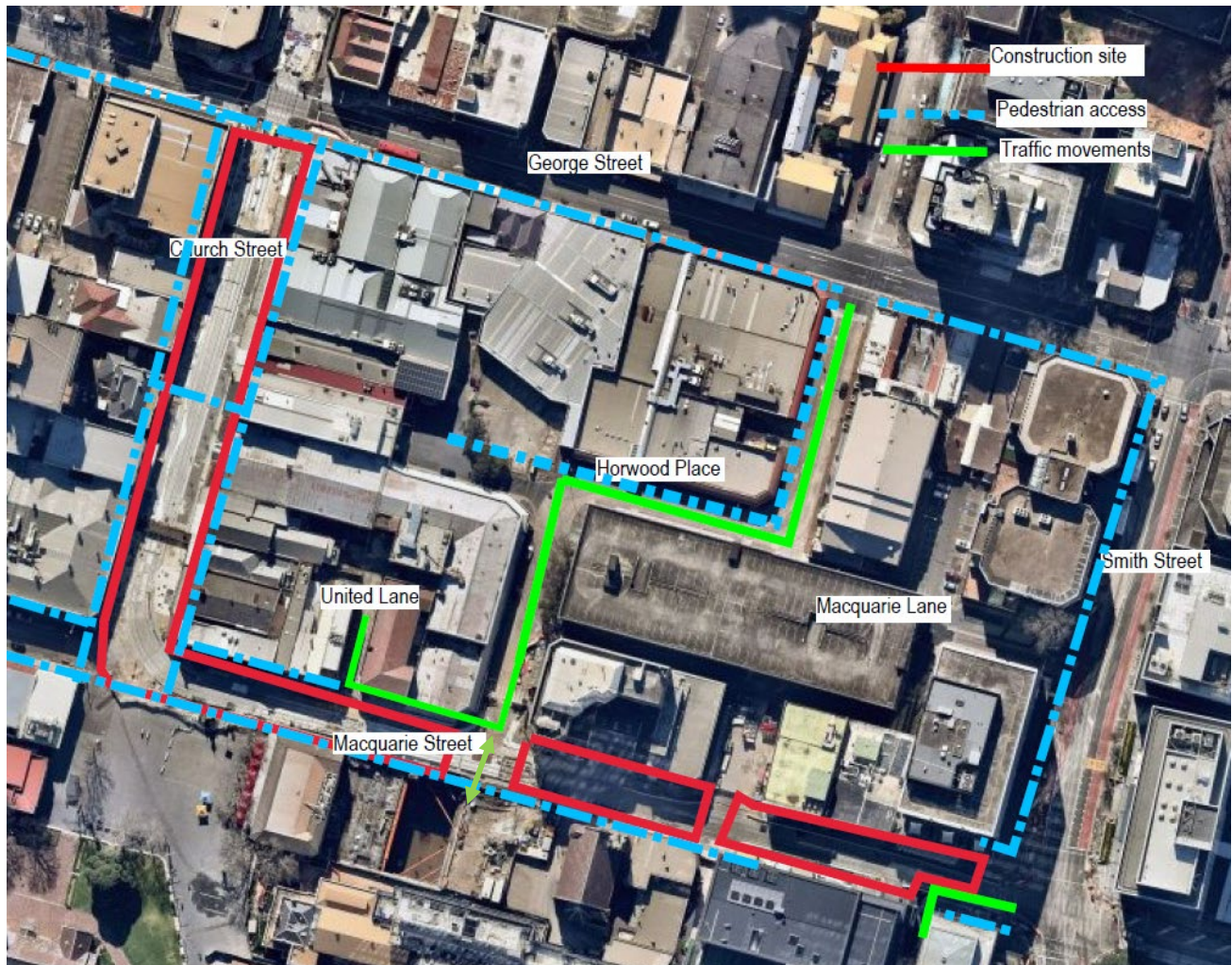
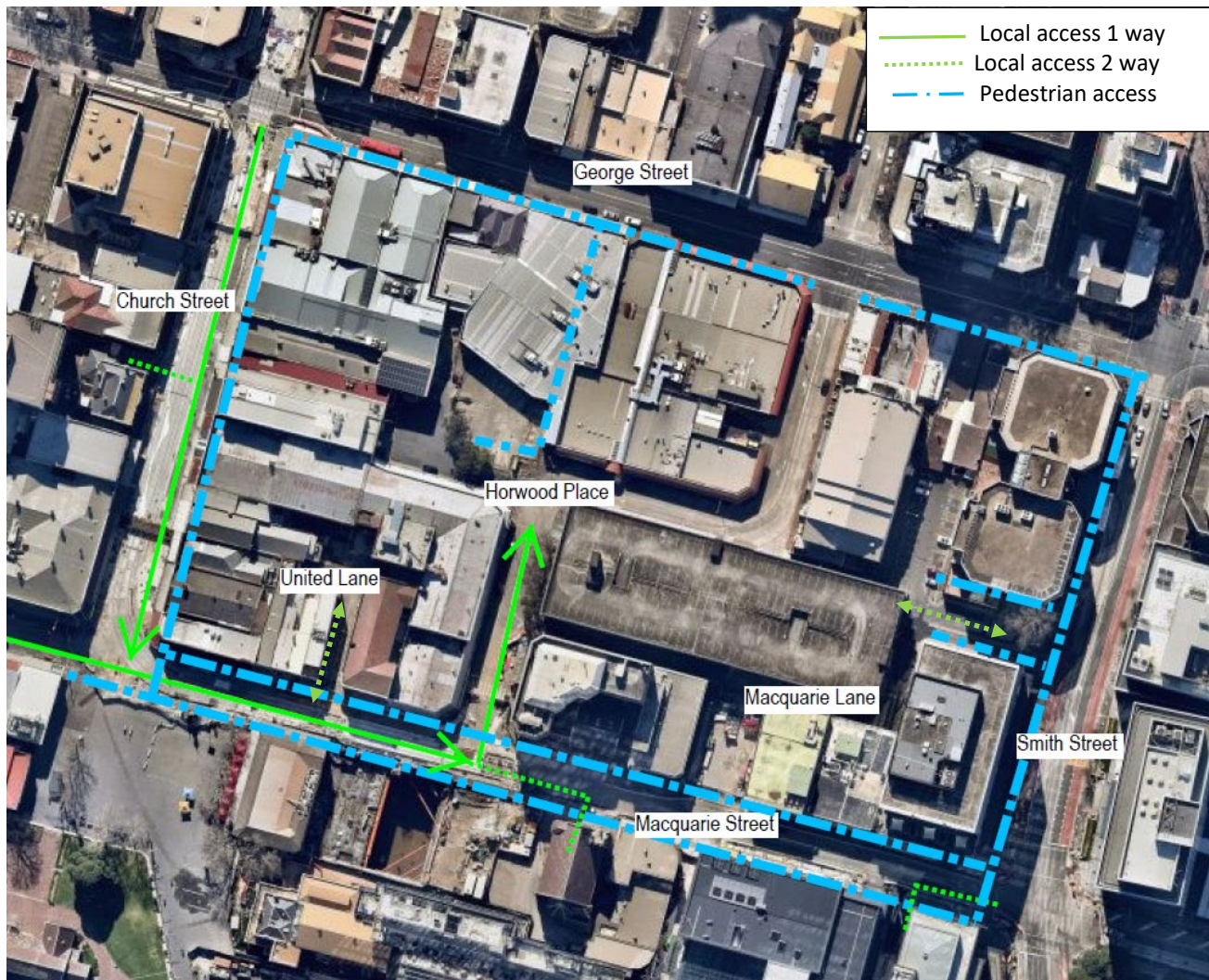

Figure 16: Parramatta Light Rail traffic arrangements mid-September 2021



Once the works on Macquarie Street between Church Street and Horwood Place are completed, Parramatta Light Rail will, before Christmas 2021, convert Macquarie Street from O’Connell Street to Horwood Place, to one way eastbound and Church Street between George Street and Macquarie Street, one way southbound. The proposed changes are as shown on Figure 17.



**Figure 17: Proposed Christmas 2021 traffic changes**

**8.3 Proposed heavy vehicle routes and management**

The scope of works issued by Sydney Metro noted that all access to the site would be provided from Macquarie Street and a one way movement would be implemented on Horwood Place with access via Macquarie and egress via George Street. As noted above, the site is currently shared access for Parramatta Light Rail and Holdmark constructions and also for the Parramatta Mission Leigh Memorial Church. Given these constraints, the current traffic arrangements will dictate the heavy vehicle access and egress arrangements. The relevant pedestrian management to be implemented is included within the site specific Construction Traffic Management Plan for Parramatta.

Trucks will be called into site and there will be sufficient on site storage to accommodate the DELTA heavy vehicles.



Two routes for access into the site were explored, as noted on Figure 18. The route from the south via Station Street was discarded as the swept path from Smith Street onto George Street was not achievable.

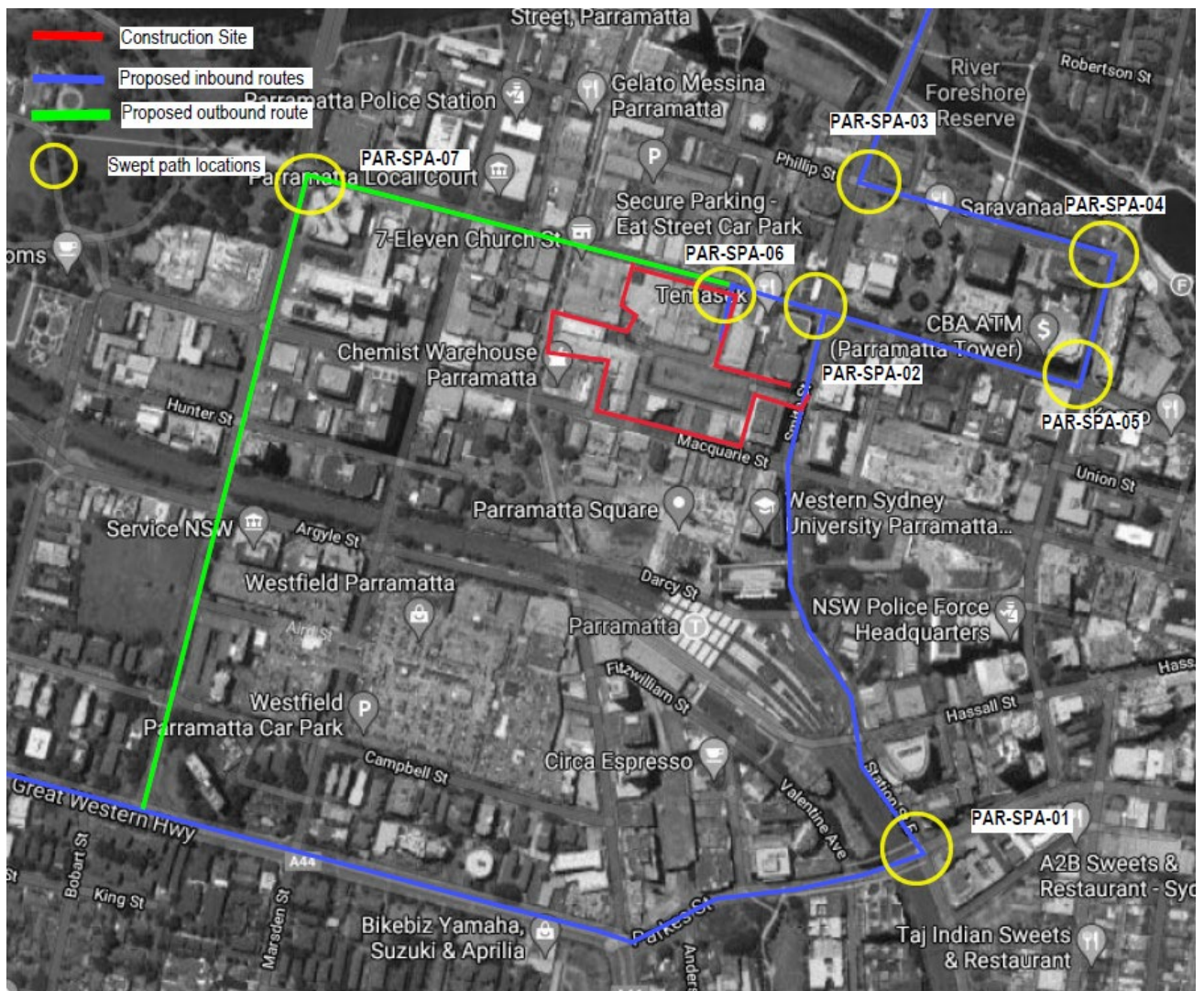

**Figure 18: Routes explored and swept path locations (indicative site boundary only)**

Therefore, the only viable route is from the north via Wilde Avenue, Phillip Street, Charles Street and George Street. This route, Figure 19, will be in use from the commencement of works 21 October 2021 through to the Christmas period, whilst Table 6 details the roads to be used that are not included in the original EIS routes and the existing road classifications. All intersections within the Parramatta CBD not included in the EIS are traffic signal controlled.

Note that the EIS outbound route via George Street, O’Connell Street will be used for all outbound heavy vehicles, as this is the only available route based on current egress restrictions at Horwood Place and George Street intersection.

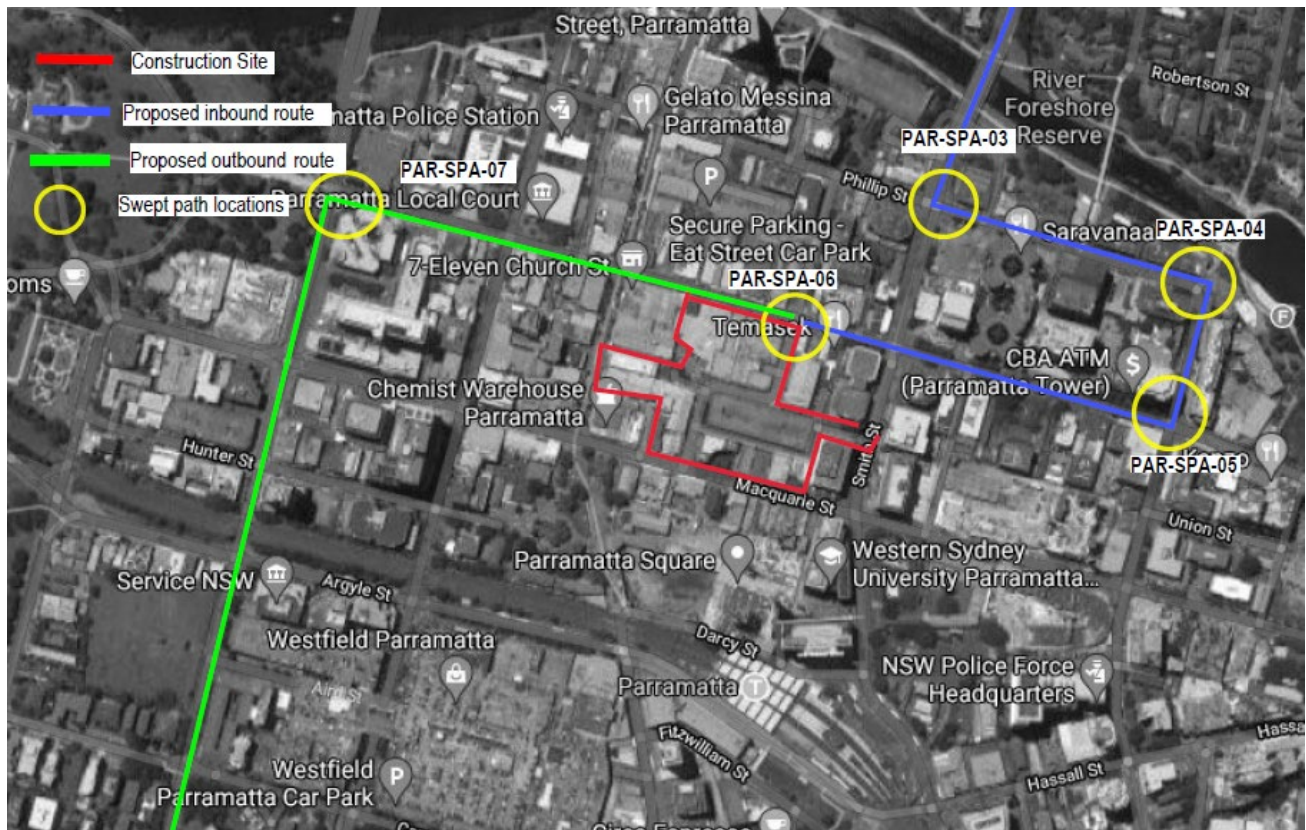

**Figure 19: Proposed inbound route (indicative site boundary only)**

**Table 6: Roads not included in the EIS**

Road	Road classification	Between	Two way traffic flow	Parking	Speed limit
Phillip Street	Local	Wilde Avenue   Charles Street	Yes	Yes	40km/hr
Charles Street	Local	Phillip Street   George Street	Yes	Yes	40km/hr
George Street	Local	Charles Street   Smith Street	Yes	Yes	40km/hr

The existing speed limits within the Parramatta CBD came into effect in November 2019. The extent of the 40km/hr zones within the Parramatta CBD are as noted on Figure 4.



Post-Christmas the following routes are proposed into site, refer to Figure 20 and Table 7. Note that the Parramatta Light Rail works are yet to be constructed therefore the swept path from Macquarie Street into Horwood Place is not available.

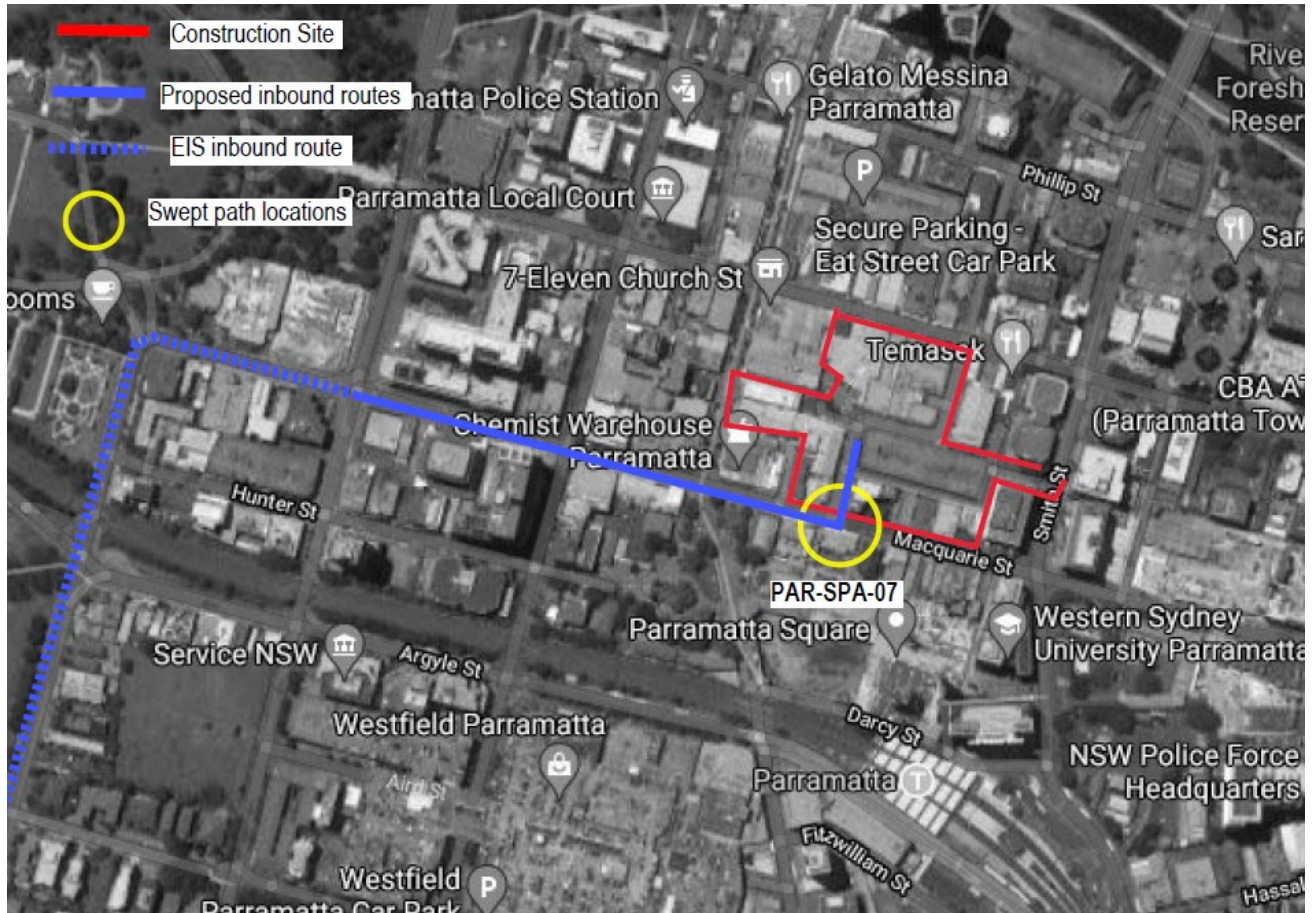

**Figure 20: Post Christmas proposed inbound route (indicative site boundary only)**

**Table 7: Roads not included in the EIS**

Road	Road classification	Between	Two way traffic flow	Parking	Speed limit
Macquarie Street	Local	O’Connell Street	Horwood Place	No	40/km/hr

The swept path analysis is provided in Appendix B with written advice from an appropriately qualified professional provided in Appendix C.

**8.3.1 Site management**

Information on the approved routes for all construction vehicles and road user awareness shall be provided through onsite toolbox talks, pre-start meetings and project inductions prior to commencing works on the project.

All work vehicles shall enter and exit the sites in a forward direction, where feasible and reasonable. Where this is not possible, appropriate traffic control will be in place.

Construction vehicle movements would be managed to minimise movements during peak periods, through appropriate scheduling. We will minimise our impacts on active transport users by only using the existing Horwood Place. Further site controls will be provided in the Construction Traffic Management Plan, where identified and appropriate.

Pedestrian and cycle access is not permitted through Horwood Place, with footpaths available in adjacent streets, refer to Figure 16 and Figure 17, other than for access to the rear of the Church Street properties. . The swept paths included in Appendix B show no encroachment onto existing footpaths or shared paths.

An indicative site layout is provided in Figure 21.



**Figure 21: Indicative site layout**

**8.3.2 Road dilapidation report**

Prior to the use of local roads by heavy vehicles associated with the works, a road dilapidation survey will be undertaken and provided to Sydney Metro and City of Parramatta Council at least one month prior to the local road use. The road dilapidation surveys were completed week commencing 20<sup>th</sup> September 2021. A copy of the transmittal to City of Parramatta Council is included in Appendix D.

**8.4 Cumulative impacts**

Cumulative impacts are identified in section 7.2. Regular contact will be maintained throughout the life of the project. This will be done through attendance at the fortnightly Traffic Control Group (TCG) and monthly Traffic and Transport Liaison Group (TTLG) meetings.

**8.4.1 Traffic Control Group (TCG)**

A Traffic Control Group (TCG) has been established by Sydney Metro, meeting fortnightly. The TCG is a technical forum to discuss the proposed traffic management measures to be used during the various stages of the Project including identification of any potential impacts on the road and transport network and mitigation measures proposed, any feedback received on the traffic documentation and updates on the program of works for the various project.

**8.4.2 Traffic and Transport Liaison Group (TTLG)**

The TTLG meets monthly, and its members comprise traffic and transport stakeholders including Emergency Services.

## 9 SAFETY

DELTA is committed to safety for all aspects of the project with road safety being paramount to the success of the project. To demonstrate this commitment the requirements listed in Table 8 will be implemented. Further details on how these specific safety mitigation measures will be implemented is provided in DELTA's Chain of Responsibility Management Plan.

**Table 8: Heavy vehicle requirements**

Requirement(s)	Purpose	Managed by
Ensure all heavy vehicles are registered and comply with the Australian Design Rules and Vehicle Standards	Ensure compliance with legislative requirements	Checking prior to attendance at site and through subcontractor engagement
Blind spot elimination or minimise front, side and rear blind spots including: <ul style="list-style-type: none"> <li>Class V and Class VI mirrors as per ADR 14/02 where blind spots cannot be permanently eliminated</li> <li>The prohibition of accessories that restrict the forward field of vehicles, including opaque or chrome bug deflectors</li> </ul>	Ensure compliance with SWTC and increase visibility of active transport users	Checking prior to attendance at site and through subcontractor engagement
Side-underrun protection fitted to both sides of the vehicle: <ul style="list-style-type: none"> <li>Between the front and rear axle of all rigid (SU) trucks and</li> <li>Between the front axle/ landing legs and rear axle of trailers forming part of a combination</li> </ul>	Improved protection for active transport users	Checking prior to attendance at site and through subcontractor engagement
Signage placed on heavy vehicles including: <ul style="list-style-type: none"> <li>Rear warning signs alerting other road users to the dangers of overtaking and</li> <li>Front nearside signs warning pedestrians about walking close to the front of a moving or stationary Heavy Vehicle</li> </ul>	increasing road safety awareness	Checking prior to attendance at site and through subcontractor engagement
Full body line and contour conspicuity markings and reflective markings fitted to the drawbar of all trailers	Increasing visibility of heavy vehicles	Checking prior to attendance at site and through subcontractor engagement
Heavy Vehicle drivers to complete to the Sydney Metro Safe Heavy Vehicle Driver Introduction Program or equivalent	Training	Induction process
Heavy vehicle operators to adhere to the approved construction traffic haulage routes at all times	Ensure compliance with MCoA and haulage route compliance	Monitored through telematics
All Heavy Vehicles used for spoil haulage must be clearly marked on the sides and rear with the project name and application number to enable immediate identification by a person viewing the Heavy Vehicle standing 20m away	Compliance with MCoA	Checking prior to attendance at site and through subcontractor engagement



## 10 CONSULTATION AND COMMUNICATION

### 10.1 Stakeholders consulted

Table 8 lists the consultation undertaken in the development of this Heavy Vehicle Local Road report. Appendix A contains comments from the various stakeholders and DELTA's responses.

**Table 9: Stakeholders consulted**

Stakeholder	Date	Consultation	Main contact people
Sydney Metro including Road Safety, Operations, Customer and Place Making	1 <sup>st</sup> September 2021	Submission of HVLR	Berin Gordon, Todd Solomon
TfNSW Customer Journey Planning	1 <sup>st</sup> September 2021	Submission of HVLR	Peter Keyes, Chris Smith
TfNSW Planning and Program	1 <sup>st</sup> September 2021	Submission of HVLR	Sean McGregor
City of Parramatta Council	1 <sup>st</sup> September 2021	Submission of HVLR	Council
Traffic Control Group	2 September 2021	Presentation	Sydney Metro, CJP, Council, Other Parramatta Contractors
Sydney Metro including Road Safety, Operations, Customer and Place Making	20 <sup>th</sup> September 2021	Resubmission of HVLR	Berin Gordon, Todd Solomon
TfNSW Customer Journey Planning	20 <sup>th</sup> September 2021	Resubmission of HVLR	Peter Keyes, Chris Smith
TfNSW Planning and Program	20 <sup>th</sup> September 2021	Resubmission of HVLR	Sean McGregor
City of Parramatta Council	20 <sup>th</sup> September 2021	Resubmission of HVLR	Council
Traffic and Transport Liaison Group	30 <sup>th</sup> September 2021	Presentation	Sydney Metro, CJP, Council, Other Parramatta Contractors
Sydney Metro including Road Safety, Operations, Customer and Place Making	7 <sup>th</sup> October 2021	Resubmission of HVLR	Berin Gordon, Todd Solomon
TfNSW Customer Journey Planning	7 <sup>th</sup> October 2021	Resubmission of HVLR	Peter Keyes, Chris Smith
TfNSW Planning and Program	7 <sup>th</sup> October 2021	Resubmission of HVLR	Sean McGregor
City of Parramatta Council	7 <sup>th</sup> October 2021	Resubmission of HVLR	Council

## 10.2 Induction

All personnel, including subcontractors, are required to attend a compulsory site induction before commencing any works on site. Similarly, visitors will be required to undertake a Visitor's induction.

The heavy vehicle routes as detailed within this report and included in the CTMP, will be included as part of the mandatory induction.

A record of all inductions will be maintained.

## 10.3 Toolbox talks

Toolbox talks will be conducted weekly as a minimum and will be used to present the status of safety and environmental performance including the compliance with this report and the approved CTMP for the site.

## APPENDICES

### A. Received comments

Project	SSI 10038 – Sydney Metro West
Document	10038-PA-47 – Heavy Vehicle Local Road Report Parramatta – Rev 2, dated sept 22 2021
Date received from Sydney Metro	Sept 22 2021
Date comments sent to Sydney Metro	Sept 29 2021

Comment No.	Condition	Requirement	DPIE comment	Project team response	DPIE comment	STATUS
1	D85 and D86	<p>D85 - Construction Traffic Management Plans (CTMPs) must be prepared in accordance with the Construction Traffic Management Framework. A copy of the CTMPs must be submitted to the Planning Secretary for information before the commencement of any construction in the area identified and managed within the relevant CTMP.</p> <p>D86 - Local roads proposed to be used by Heavy Vehicles to directly access construction sites that are not identified in the documents listed in Condition A1 of this schedule must be approved by the Planning Secretary and be included in the CTMPs.</p>	<p><b>DPIE comment 1.1: Please provide an updated Parramatta CTMP that includes the local roads usage updates</b></p>	<p>Requesting Sydney Metro to provide information for DPIE</p>		
2	D87	<p>All requests to the Planning Secretary for approval to use local roads under Condition D86 above must include the following:</p> <p>(a) a swept path analysis;</p>	<p>Appendix B contains all required swept path analysis for the listed local roads.</p> <p><b>CLOSED</b></p>	Noted		
	D87	<p>(b) demonstration that the use of local roads by Heavy Vehicles for the CSSI will not compromise the safety of pedestrians and cyclists of the safety of two-way traffic flow on two-way roadways;</p>	<p>Addressed in Sections 6.1, 8.3, 9 and Appendix B.</p> <p>Pg. 46 – Review comment from Kenneth Richards states “Swept path for the turn from Phillip St to Charles St - there is a bus stop on the approach side to this bend and a disabled parking space on the departure side of the turn that might prevent the turn for the truck and dog occurring without the vehicle crossing over the centreline. It needs to be confirmed if the turn can be made with both the bus stop and disabled parking space being occupied.”</p> <p><b>DPIE comment 2.1: No response was listed from the project in regard to this?</b></p>	Document amended		
	D87	<p>c) Details as to the date of completion of the road dilapidation surveys for the subject local roads and</p>	<p>Section 8.3.2. See below comment 3.1 regarding evidence of dilapidation surveys and completion dates.</p> <p><b>CLOSED</b></p>	Noted		
	D87	<p>d) Measures that will be implemented to avoid where practicable the use of local roads past schools, aged care facilities childcare</p>	<p>Section 7.1.2 – measures are briefly listed, refers to CTMP for full details, which is yet to be submitted and will be assessed later.</p> <p><b>CLOSED</b></p>	Noted		

		facilities during their peak operation times				
	D87	e) Written advice from an appropriately qualified professional on the suitability of the proposed Heavy Vehicle route which takes into consideration items (a) to (d) Appendix C Table 2: Revised Environmental Management Measure	Attachment A, Appendix C contains Independent expert endorsement of the proposed local roads uses, this was provided by Alex Gosper, the Director of CivLink consulting and a Level 3 Road Safety Auditor.  <b>CLOSED</b>	Noted		
3	D88	A copy of the Road Dilapidation Report must be provided to the Relevant Road Authority(s) within three (3) weeks of completion of the survey and at no later than one (1) month before the road being used	Section 8.3.2 Road dilapidation report states "The road dilapidation surveys will be completed by 20th September 2021 and the reports provided to Council that week."  <b>DPIE comment 3.1: Please provide evidence that the dilapidation reports have been provided to council</b>	Road Dilapidation Report Transmittal included in Appendix D		
General comments /Editorial						
			Appendix A of the HVLR contains the consultation feedback comments. It is unclear in the table which comments remain outstanding and which comments have been fully closed out.  <b>DPIE comment 4.1: Please amend the plan to clearly show that all comments have been addressed, or reasons why they have not been addressed.</b>	Revision 4 addressed to close out all comments		
Revised Environmental Mitigation Measures (REMMs)						
	TT6	All trucks would enter and exit construction sites in a forward direction, where feasible and reasonable	Section 8 figures 13 to 21 display site entrances, exits and vehicle directions to be used.  <b>CLOSED</b>	Noted		
	TT7	Construction site traffic would be managed to minimise movements during peak periods	Section 8.3.1 stats "Construction vehicle movements would be managed to minimise movements during peak periods, through appropriate scheduling. We will minimise our impacts on active transport users by only using the existing Horwood Place. Further site controls will be provided in the Construction Traffic Management Plan, where identified and appropriate. Pedestrian and cycle access is not permitted through Horwood Place"  <b>CLOSED</b>	Noted		
	TT8	Construction site traffic immediately around construction sites would be managed to minimise vehicle movements through school zones during pick up and drop off times	Section 8.3.1 stats "Construction vehicle movements would be managed to minimise movements during peak periods, through appropriate scheduling. We will minimise our impacts on active transport users by only using the existing Horwood Place. Further site controls will be provided in the Construction Traffic Management Plan, where identified and appropriate. Pedestrian and cycle access is not permitted through Horwood Place"  Pg. 46: Independent traffic consultant letter of support – "The proposed use of the additional sections of local roads is expected to have limited to no adverse impact on sensitive facilities, cyclists or pedestrians".  <b>CLOSED</b>	Noted		

	TT24	<p>Coordination and consultation with the following stakeholders would occur, where required, to manage the interface of projects under construction at the same time:</p> <ul style="list-style-type: none"> <li>• Transport for NSW including Transport Coordination</li> <li>• Department of Planning, Industry and Environment</li> <li>• Sydney Trains</li> <li>• NSW Trains</li> <li>• Sydney Buses</li> <li>• Sydney Water</li> <li>• Port Authority of NSW</li> <li>• Sydney Motorways Corporation</li> <li>• Emergency service providers</li> <li>• Utility providers</li> <li>• Construction contractors</li> </ul> <p>Coordination and consultation with these stakeholders would include:</p> <ul style="list-style-type: none"> <li>• Provision of regular updates to the detailed construction program, construction sites and haul routes</li> <li>• Identification of key potential conflict points with other construction projects</li> <li>• Developing mitigation strategies in order to manage conflicts. Depending on the nature of the conflict this could involve: <ul style="list-style-type: none"> <li>o Adjustments to the Sydney Metro construction program work activities or haul routes or adjustments to the program activities or haul routes of other construction projects</li> </ul> </li> <li>• Coordination of traffic management arrangements between projects</li> </ul>	<p>Section 8.4 &amp; 10, Table 9 details consultation that occurred with required groups regarding the HVLR</p> <p><b>CLOSED</b></p>	Noted		
--	------	---	--	-------	--	--

DOCUMENT NO.	TITLE	VER	STATUS	NO.	DATE	COMPANY	RAISED BY	REVIEW DOC. NO.*	DOCUMENT REF*	DEED REF*	COMMENTS / RESPONSE	COMMENT CATEGORY*	CLOSED OUT
				07	7/09/2021	SMD	[REDACTED]	SMWSDDS-DLT-PTA-TF-REP-000059	6.1 Construction vehicles and plant	General Specification 2.11	Section 6.1 Construction vehicles and plant states: 'Heavy Vehicles – rigid trucks, articulated trucks, crane trucks' will be used. Furthermore, it is noted in Appendix B, the swept path's provided are for a Truck and (Quad) Dog combination. Please provide further clarity on the specific heavy vehicle types that will be used for this site given the road access constraints in Parramatta CBD and Horwood place. Please confirm the articulated truck types expected to be used at Parramatta (e.g. limited to 19m (General Access) semi-trailers and low-loaders?) and if truck and dog combinations be utilised for Parramatta. If semi-trailer combinations will be used, can swept paths be made available for these movements as well?	Observation	N
							[REDACTED]	SMWSDDS-DLT-PTA-TF-REP-000059	6.1 Construction vehicles and plant	General Specification 2.11	Document amended Section 7.1	Observation	N
				07.01	20/09/2021	DLT	[REDACTED]	SMWSDDS-DLT-PTA-TF-REP-000059	6.1 Construction vehicles and plant	General Specification 2.11	Document amended	Observation	N
							[REDACTED]	SMWSDDS-DLT-PTA-TF-REP-000059	6.1 Construction vehicles and plant	General Specification 2.11	Document amended Section 7.1	Observation	N
				07.01.01	24/09/2021	SMD	[REDACTED]	SMWSDDS-DLT-PTA-TF-REP-000059	NA	General Specification 2.11	Please clarify what amendments have been made (and where) as the relevant sections have not been updated	Observation	N
							[REDACTED]	SMWSDDS-DLT-PTA-TF-REP-000059	NA	General Specification 2.11	Document amended Section 7.1	Observation	N
				12	7/09/2021	TFN	[REDACTED]	SMWSDDS-DLT-PTA-TF-REP-000059	Figure 17	2.11.1 (f) of the General Specification	Changes to the EIS routes are proposed post December 21 along Macquarie Street however no analysis or reasoning has been provided. This alternative route travels through the heart of the Parramatta CBD where there are significant pedestrian volumes. How this increased exposure will be managed and a safety assessment of the proposed route needs to be included, especially between Church Street and Horwood Place, for an accurate assessment to be made.	Minor Non-Compliance	N
							[REDACTED]	SMWSDDS-DLT-PTA-TF-REP-000059	Figure 17	2.11.1 (f) of the General Specification	This is the route provided by Sydney Metro as part of the Demolition contract award. The initial route (Sept to Dec) is a compromise route to allow all works as noted in section 8.2 and as noted in section 8.3. Pedestrians will be maintained on the southern footpath of Macquarie Street only removing the interface between vehicles and pedestrians at the intersection of Horwood Place and Macquarie Street	Minor Non-Compliance	N
				12.01	20/09/2021	DLT	[REDACTED]	SMWSDDS-DLT-PTA-TF-REP-000059	Figure 17	2.11.1 (f) of the General Specification	This is the route provided by Sydney Metro as part of the Demolition contract award. The initial route (Sept to Dec) is a compromise route to allow all works as noted in section 8.2 and as noted in section 8.3	Minor Non-Compliance	N
							[REDACTED]	SMWSDDS-DLT-PTA-TF-REP-000059	Figure 17	2.11.1 (f) of the General Specification	This is the route provided by Sydney Metro as part of the Demolition contract award. The initial route (Sept to Dec) is a compromise route to allow all works as noted in section 8.2 and as noted in section 8.3. Pedestrians will be maintained on the southern footpath of Macquarie Street only removing the interface between vehicles and pedestrians at the intersection of Horwood Place and Macquarie Street	Minor Non-Compliance	N



DOCUMENT NO.	TITLE	VER	STATUS	NO.	DATE	COMPANY	RAISED BY	REVIEW DOC. NO.*	DOCUMENT REF*	DEED REF*	COMMENTS / RESPONSE	COMMENT CATEGORY*	CLOSED OUT
				12.01.01	23/09/2021	TFN					Response noted - will adjust to minor non compliance as there are still requirements to consider safety risks and how they will be minimised through such a highly pedestrianised area. If Sydney Metro can't provide this analysis and risk assessment when the route was decided on then please consider the risks and demonstrate what controls will be implemented along Macquarie Place to reduce the risk to other road users, especially pedestrians. Example controls may include instructions to drivers not to queue across intersections (Church and Macquarie), spotters or traffic controllers managing pedestrians while vehicles turn into Horwood Place, and additional safety messaging and awareness for pedestrians on the presence of heavy vehicles in the form of pavement decals at either side of Horwood Place.	Minor Non-Compliance	N
											Pedestrian access will be restricted to the southern side of Macquarie Street, other than for access to the retail premises between Church Street and United Lane on the northern side of Macquarie Street	Minor Non-Compliance	N
				24	10/09/2021	SMD		SMWSDDS-DLT-PTA-TF-REP-000059	Figure 8	General Specification	This figure shows the surrounding social infrastructure, but there is no discussion/analysis on how the proposed non EIS heavy vehicles routes impact them or what the mitigations may be if they do. This does not address MCoA87(B). Update HVLR accordingly.	Minor Non-Compliance	N
								SMWSDDS-DLT-PTA-TF-REP-000059	Figure 8	General Specification	Document amended	Minor Non-Compliance	N
				24.01	20/09/2021	DLT		SMWSDDS-DLT-PTA-TF-REP-000059	Figure 8	General Specification	This section is describing Existing Conditions. As noted in the report there is no other available routes- refer to Section 8	Minor Non-Compliance	N
								SMWSDDS-DLT-PTA-TF-REP-000059	Figure 8	General Specification	Figure updated	Minor Non-Compliance	N
				24.01.01	22/09/2021	SMD					Yes, the map shows existing conditions, the route proposed goes past that (and other) existing conditions. For example one of the existing conditions is Western Sydney University. Does the route proposed have an impact on students and the University? If so, what are the mitigation? That is what is required by DPIE.	Minor Non-Compliance	N
											There is no impact to Western Sydney University as it is located on Smith Street between Phillip Street and George Street which is not part of the proposed heavy vehicle route	Minor Non-Compliance	N
				37	17/09/2021	HBI		SMWSDDS-DLT-PTA-TF-REP-000059	Heavy Vehicle Local Road Report - Table 1	D87	Table 1: Ministerial Conditions of Approval requirements for HVLRMcoA D83 relevant to HV is not addressed in this Table and document. Review/update accordingly.	Actual Non-Compliance	N
								SMWSDDS-DLT-PTA-TF-REP-000059	Heavy Vehicle Local Road Report - Table 1	D87	Not applicable - refer to Schedule 20 from Sydney Metro	Actual Non-Compliance	N
				37.01	22/09/2021	DLT					Document previously amended based on previously received comments	Actual Non-Compliance	N
											Not applicable - refer to Schedule 20 from Sydney Metro	Actual Non-Compliance	N
				37.02	24/09/2021	HBI					Closed 24/09/21. Noted comment is outstanding and recommend being addressed, however closed in interest of sending document to DPIE	Actual Non-Compliance	N
											Not applicable - refer to Schedule 20 from Sydney Metro	Actual Non-Compliance	N
				37.02.01	27/09/2021	SMD					This item is still open and has not been adequately addressed (previous response from Swathi notes this). Please address accordingly.	Actual Non-Compliance	N
											Not applicable - refer to Schedule 20 from Sydney Metro	Actual Non-Compliance	N
				44	24/09/2021	PAR		SMWSDDS-DLT-PTA-TF-REP-000059	Table 4. EIS and DELTA proposed HV-movements		It is unclear what the proposed construction hours are as the HVLR only mentioned 7am to 6pm but not the days and whether there will be work on weekends and public holidays. Also, typically, demolition works are between Monday to Friday 7am to 5pm and this appears to be consistent with their EIS HV movements shown in Figure 7. Their construction hours appears to end at 6pm. Will Delta Group be permitted longer demolition hours?	Observation	N

DOCUMENT NO.	TITLE	VER	STATUS	NO.	DATE	COMPANY	RAISED BY	REVIEW DOC. NO.*	DOCUMENT REF*	DEED REF*	COMMENTS / RESPONSE	COMMENT CATEGORY*	CLOSED OUT
								SMWSDDS-DLT-PTA-TF-REP-000059	Table 4. EIS and DELTA proposed HV movements		Working hours are as per MCoA D35 - Work must only be undertaken during the following hours: a) 7.00am to 6.00pm Mondays to Fridays, inclusive, b) 8.00am to 6.00pm Strudays, and c) at no time on Sundays or Public Holidays	Observation	N
				45	24/09/2021	PAR		SMWSDDS-DLT-PTA-TF-REP-000059	Appendix B - Swept paths		Swept path plans were not provided for the egress routes to demonstrate HVs can safely manoeuvre at critical intersections.	Observation	N
								SMWSDDS-DLT-PTA-TF-REP-000059	Appendix B - Swept paths		Now included	Observation	N
				46	24/09/2021	PAR		SMWSDDS-DLT-PTA-TF-REP-000059	Section 6. Project works		There were no mentions of work zones or hoarding required in the HVLR.	Observation	N
								SMWSDDS-DLT-PTA-TF-REP-000059	Section 6. Project works		Hoarding details are included in the relevant Construction Traffic Management Plan	Observation	N
				47	24/09/2021	PAR		SMWSDDS-DLT-PTA-TF-REP-000059	Section 7.3.1 Site management		also did not mention how they will manage the arrival of HVs so that they do not store on street. Should trucks be stored on site at all times, this should be clarified in the report.	Observation	N
								SMWSDDS-DLT-PTA-TF-REP-000059	Section 7.3.1 Site management		Document amended section 8.3	Observation	N
				48	24/09/2021	PAR		SMWSDDS-DLT-PTA-TF-REP-000059	Section 6. Project works		There were plans previously to signalise George Street and Horwood Place to facilitate Parramatta Station construction works. Is this still proceeding? If so, should this intersection be signalised during these works, reference should be made regarding this in the HVLR and swept paths should be updated to show the signalised intersection.	Observation	N
								SMWSDDS-DLT-PTA-TF-REP-000059	Section 6. Project works		Signalisation will occur when the Main Works Western Tunnelling Package contractor is on site. Signals are not required for the demolition works.	Observation	N
				49	24/09/2021	PAR		SMWSDDS-DLT-PTA-TF-REP-000059	Figure 15:Proposed inbound route, page 22		Wilde Avenue bridge – Sydney Metro may need to do their own structural assessment of the bridge and submit such report through NHVR with their application for heavy vehicle access.	Observation	N
								SMWSDDS-DLT-PTA-TF-REP-000059	Figure 15:Proposed inbound route, page 22		All vehicles will be General Access vehicles which do require NHVR applications, as noted at <a href="https://www.nhvr.gov.au/road-access/mass-dimension-and-loading/general-access-vehicle">https://www.nhvr.gov.au/road-access/mass-dimension-and-loading/general-access-vehicle</a>	Observation	N
				50	24/09/2021	PAR		SMWSDDS-DLT-PTA-TF-REP-000059	Figure 17: Post Christmas proposed inbound route		Inbound route on Macquarie Street is currently not feasible due to configuration of the intersection on O'Connell Street and the fact that Macquarie Street is one-way westbound. If this route is planned to be used, Metro will have to coordinate with Parramatta Light Rail as that project will make changes to the intersection and Macquarie Street.	Observation	N
								SMWSDDS-DLT-PTA-TF-REP-000059	Figure 17: Post Christmas proposed inbound route		Noted, ongoing coordination meetings are held between Sydney Metro, TfNSW's Parramatta Light Rail project tem, Parramatta Connect, CJP and DELTA on access arrangements	Observation	N
				51	24/09/2021	PAR		SMWSDDS-DLT-PTA-TF-REP-000059	General Comment		It has been proposed that the applicant will provide a dilapidation report for affected roads. Once the project is completed, they will either rectify any damage or pay for its repair. This is fine, however, there is no information on the regime of regular road inspections and who will be doing maintenance during the project.	Observation	N
								SMWSDDS-DLT-PTA-TF-REP-000059	General Comment		There is no requirement for maintenance of roads	Observation	N
				52	24/09/2021	PAR		SMWSDDS-DLT-PTA-TF-REP-000059	General Comment		There is no information on any compensation to Council for long term damage to road pavements such as an increase in pavement wear as result of increased number of heavy vehicles on roads. During the other project that affected some roads in Epping (Sydney Metro North project), we received compensation for increased number of buses on our roads during the closure of railway line. The compensation was calculated in accordance with TfNSW publication: Roads and Maritime Services Report, Analysis of Marginal Cost of Road Wear - Based on pavement life cycle costing', 21st April 2011. Could the same methodology be used in this case?	Observation	N

DOCUMENT NO.	TITLE	VER	STATUS	NO.	DATE	COMPANY	RAISED BY	REVIEW DOC. NO.*	DOCUMENT REF*	DEED REF*	COMMENTS / RESPONSE	COMMENT CATEGORY*	CLOSED OUT
								SMWSDDS-DLT-PTA-TF-REP-000059	General Comment	-	There is no requirement for maintenance	Observation	N
				53	24/09/2021	PAR		SMWSDDS-DLT-PTA-TF-REP-000059	General Comment	-	The applicant provided map showing that the affected roads are part of PBS network. This map must be read in conjunction with map of restricted structures. (See note regarding Wilde Ave bridge above.)	Observation	N
								SMWSDDS-DLT-PTA-TF-REP-000059	General Comment	-	All of the issues raised were incorporated into the revised document sent to TfNSW on 20 September	Observation	N
				54	24/09/2021	PAR		SMWSDDS-DLT-PTA-TF-REP-000059	General Comment	-	Due to installation of underground utility services, some of our road sections (pavements or footpath areas) might be affected. There needs to be an agreement on road restoration in accordance with Council's procedures.	Observation	N
								SMWSDDS-DLT-PTA-TF-REP-000059	General Comment	-	All of the issues raised were incorporated into the revised document sent to TfNSW on 20 September	Observation	N

## B.Swept path analysis and legislation

Drawing	Location	Suitability	Route
PAR-SPA-01	Parkes Street at Station Street	Swept path is suitable	Parkes Street/ Station Street/ Smith Street/ George Street
PAR-SPA-02	Smith Street at George Street	Swept path is <b>NOT</b> suitable	Parkes Street/ Station Street/ Smith Street/ George Street
PAR-SPA-03	Wilde Avenue at Phillip Street	Swept path is suitable	Wilde Avenue, Phillip Street, Charles Street, George Street
PAR-SPA-04	Phillip Street at Charles Street	Swept path is suitable	Wilde Avenue, Phillip Street, Charles Street, George Street
PAR-SPA-05	Charles Street at George Street	Swept path is suitable	Wilde Avenue, Phillip Street, Charles Street, George Street
PAR-SPA-06	George Street at Horwood Place	Swept path is suitable	Wilde Avenue, Phillip Street, Charles Street, George Street
PAR-SPA-07	George Street at Horwood Place	Swept path is suitable	George Street, O'Connell Street
PAR-SPA-08	George Street at O'Connell Street	Swept path is suitable	George Street, O'Connell Street
PAR-SPA-09	Macquarie Street at Horwood Place	Unable to be completed as works are yet to be completed	Macquarie Street, Horwood Place



GENERAL NOTES  
 - 500MM VEHICLE BODY SHOWN WITH DASHED LINE  
 - DESIGN VEHICLE SWEEP PATH COMPLETED AT 5KPH  
 - ALL SWEEP PATHS COMPLETED ON SCALED AERIAL IMAGERY AND SHOULD BE VARIFIED ON SITE PRIOR TO HAULAGE OPERATIONS

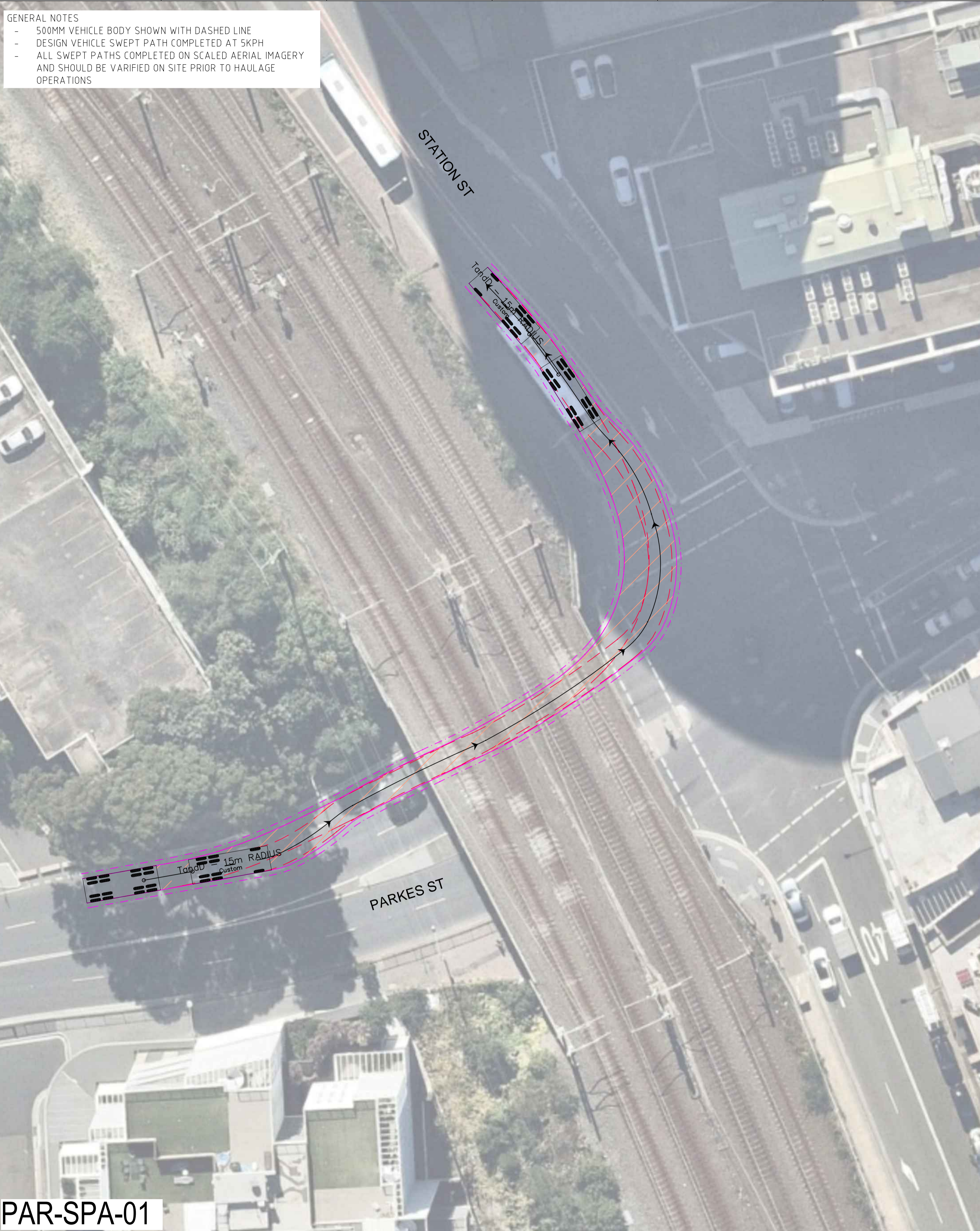

PAR-SPA-01



PAR-SPA-02

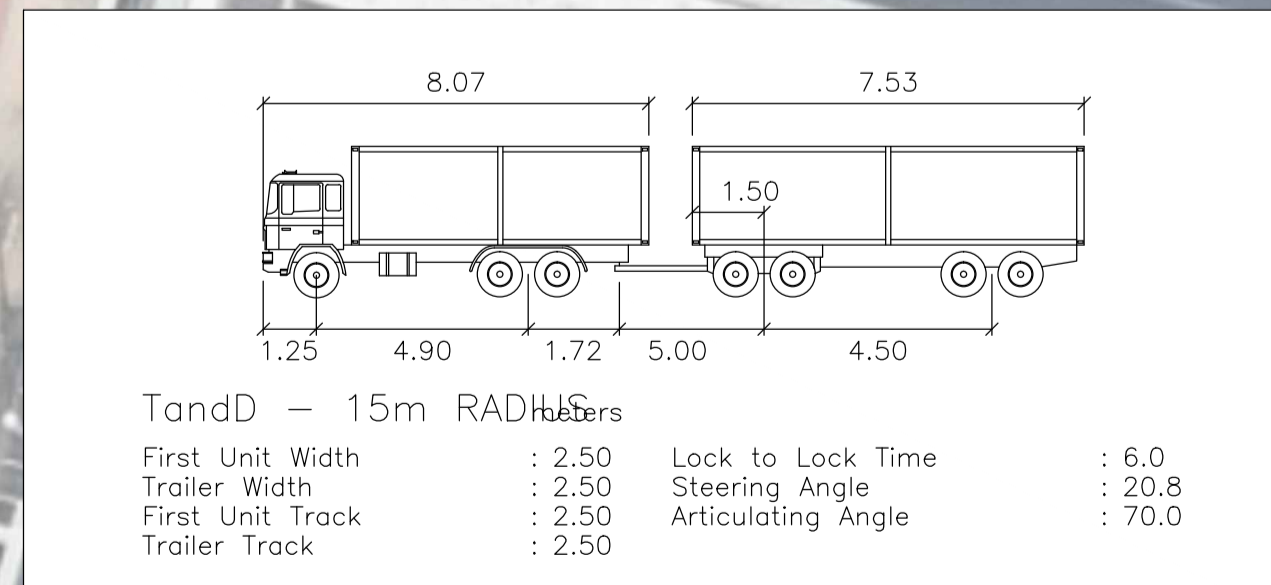

REV	BY	DATE	DESCRIPTION	APPD.
A	SS	29/08/21	INITIAL DRAFT	SL
COORDINATE SYSTEM:			HEIGHT DATUM:	SCALE:

DRAWN BY:	SS
DRW CHECK:	SL
APPROVED:	SL
IND REVIEW:	SL



DELTA  
PARAMATTA  
SWEEP PATH ANALYSIS

DRAWING No:	PAR-SPA-01&02	
SHEET	1	OF 1
REVISION	A	



GENERAL NOTES  
 - 500MM VEHICLE BODY SHOWN WITH DASHED LINE  
 - DESIGN VEHICLE SWEEP PATH COMPLETED AT 5KPH  
 - ALL SWEEP PATHS COMPLETED ON SCALED AERIAL IMAGERY AND SHOULD BE VERIFIED ON SITE PRIOR TO HAULAGE OPERATIONS

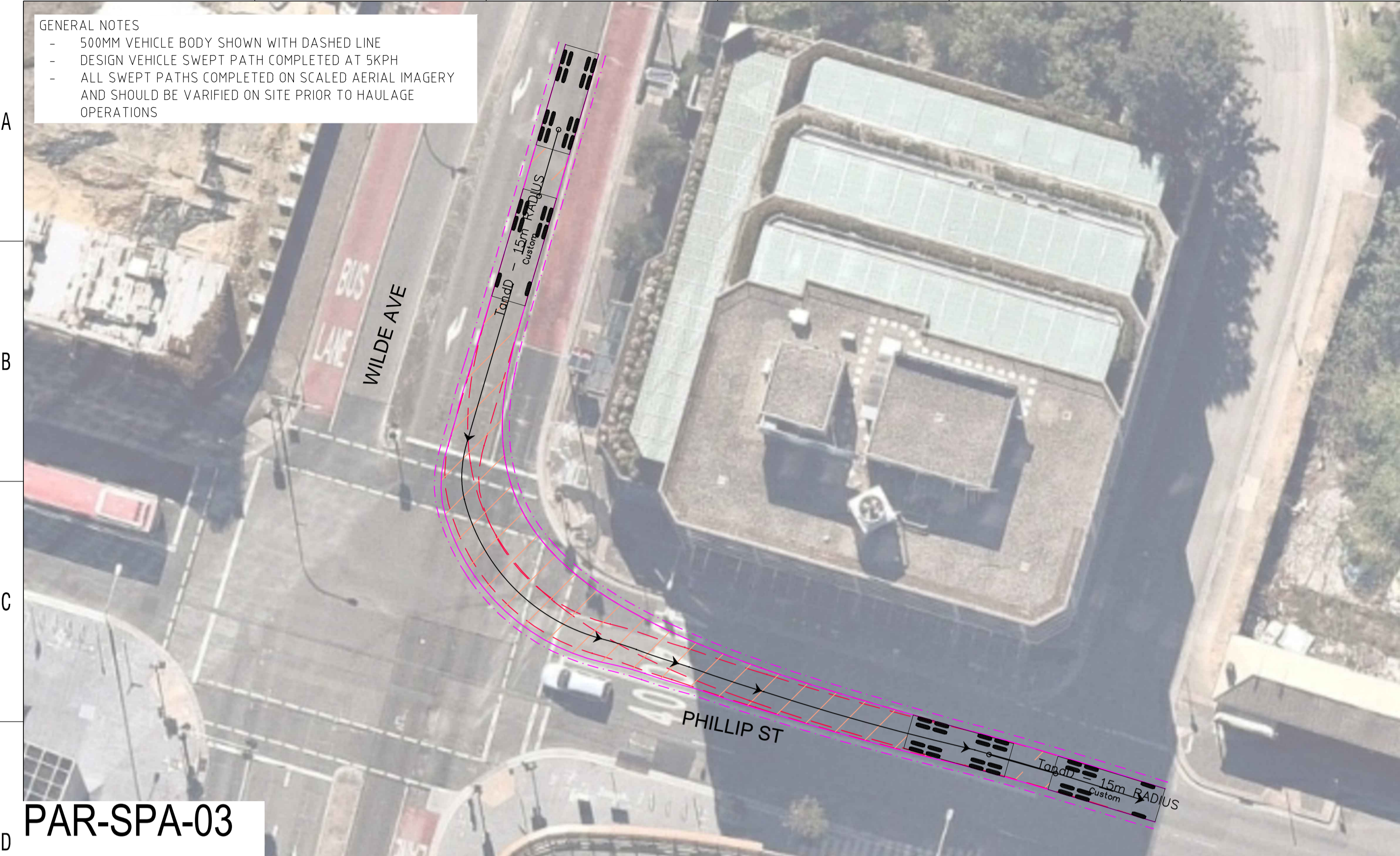

PAR-SPA-03

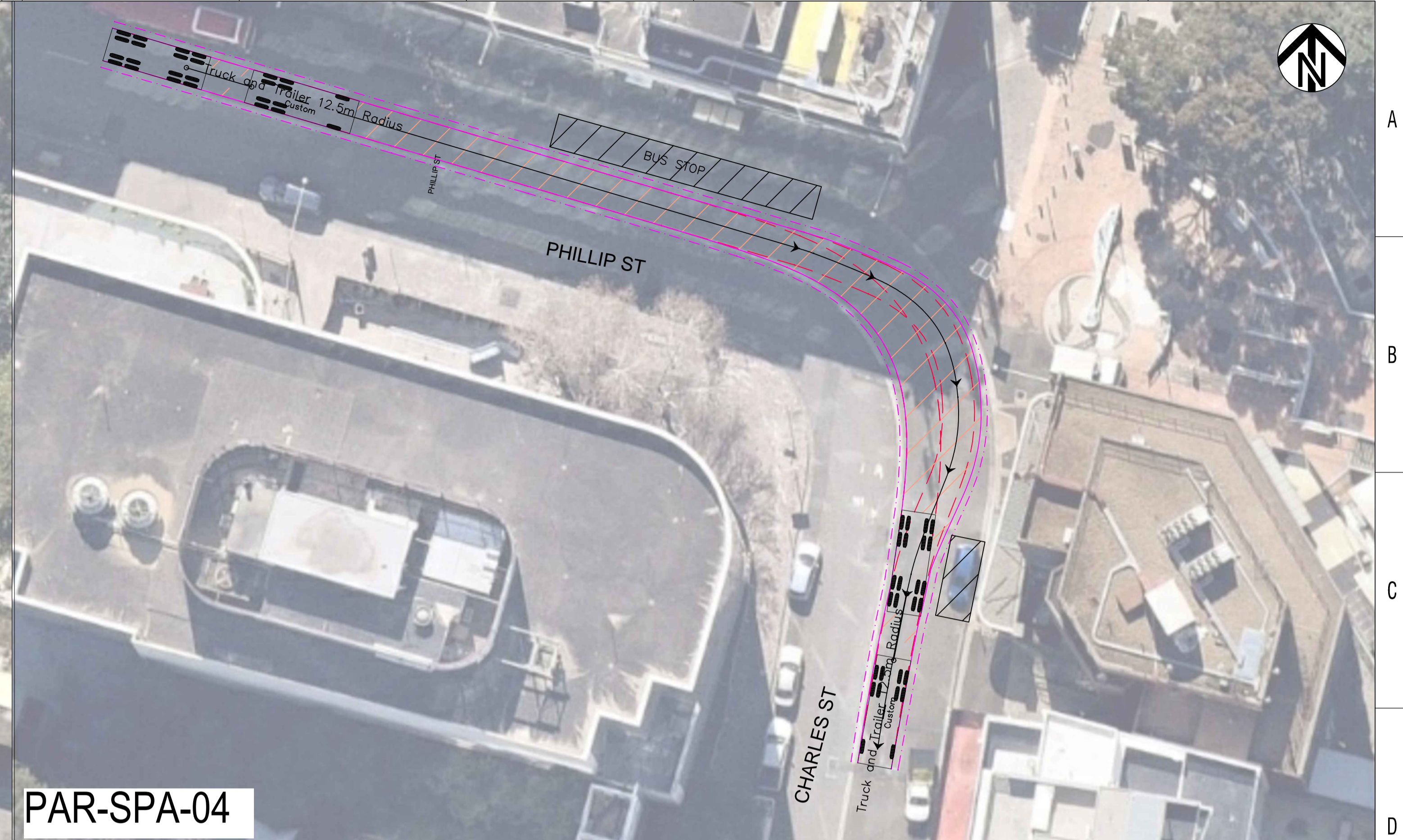

PAR-SPA-04

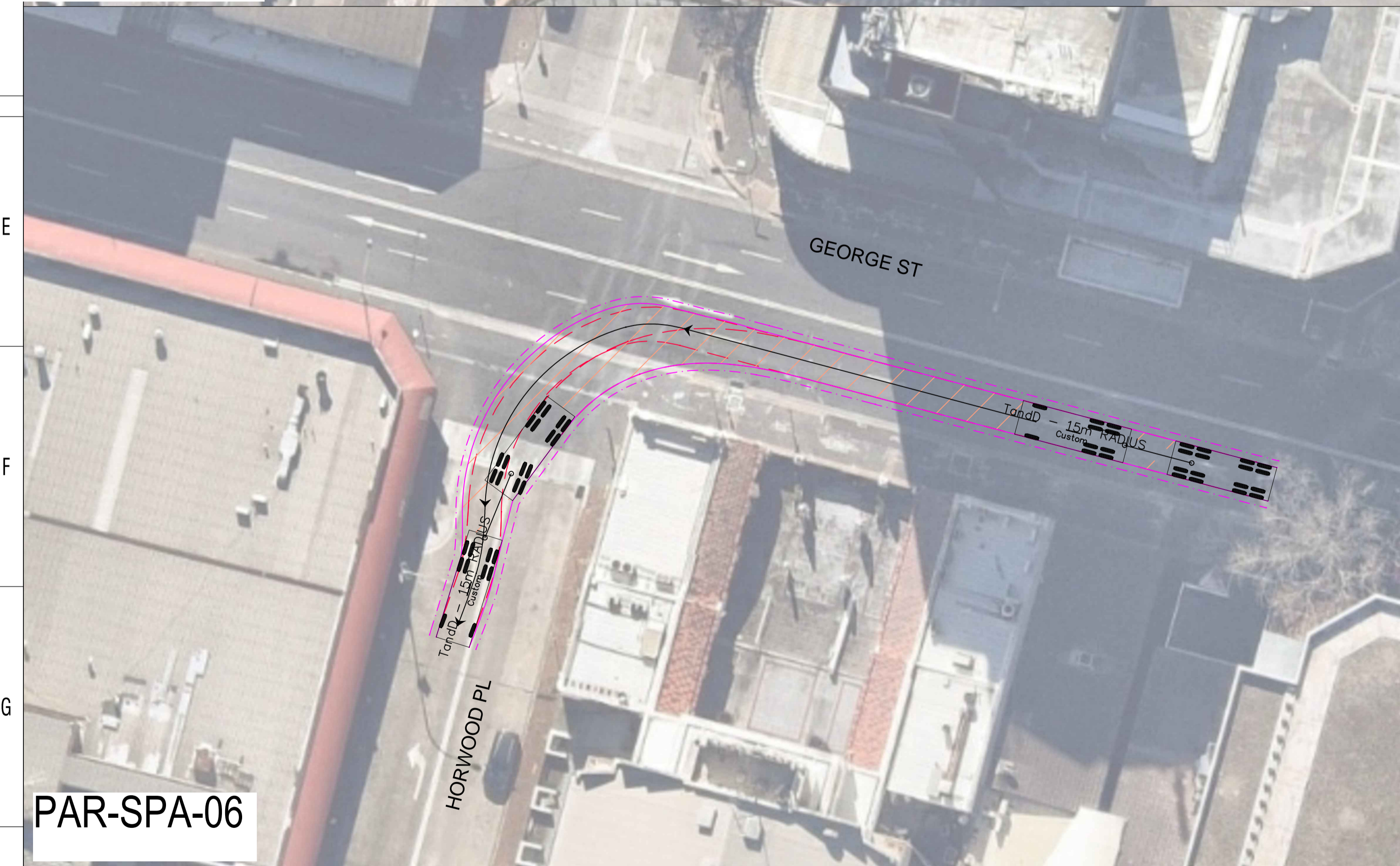

PAR-SPA-06

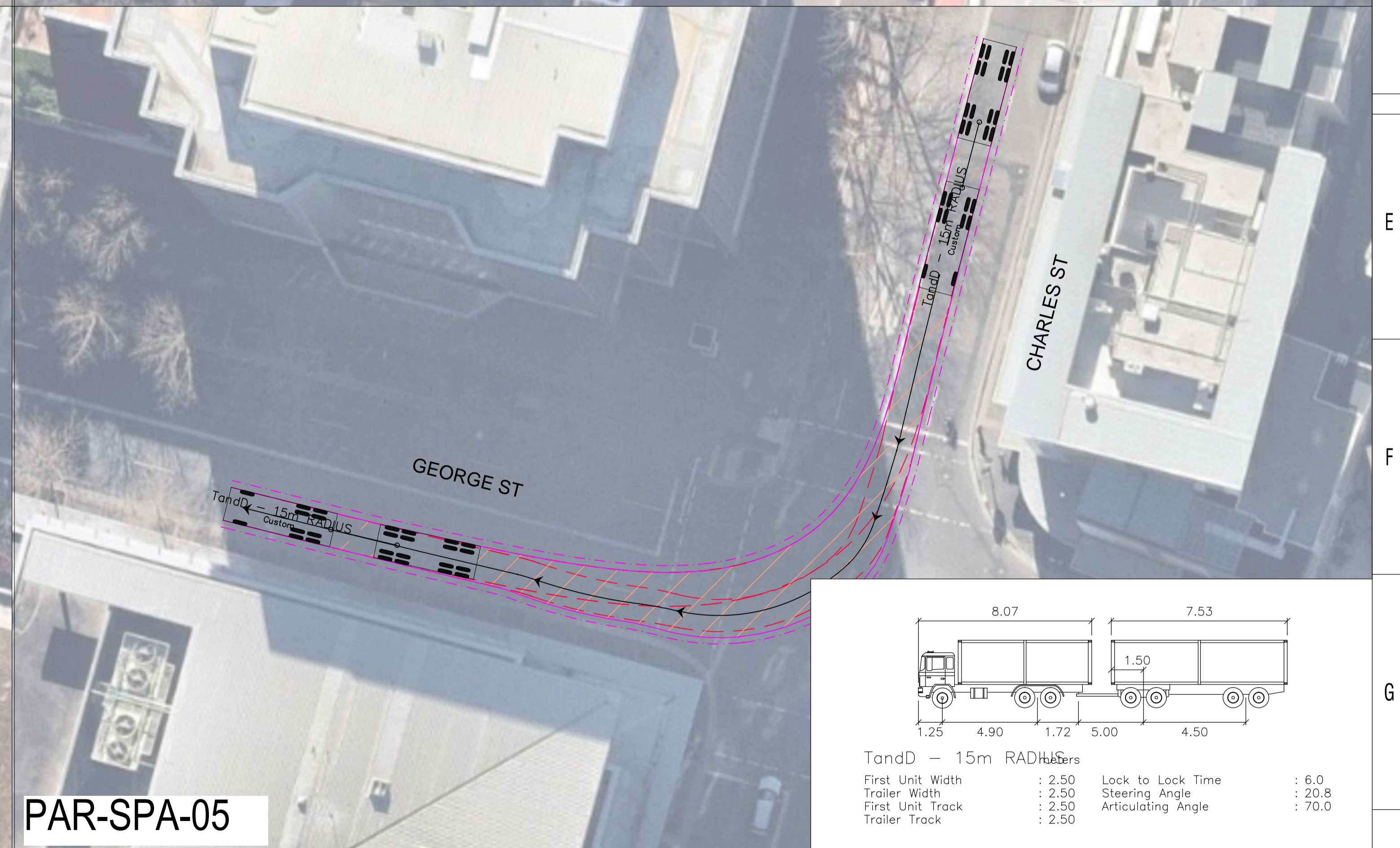

PAR-SPA-05

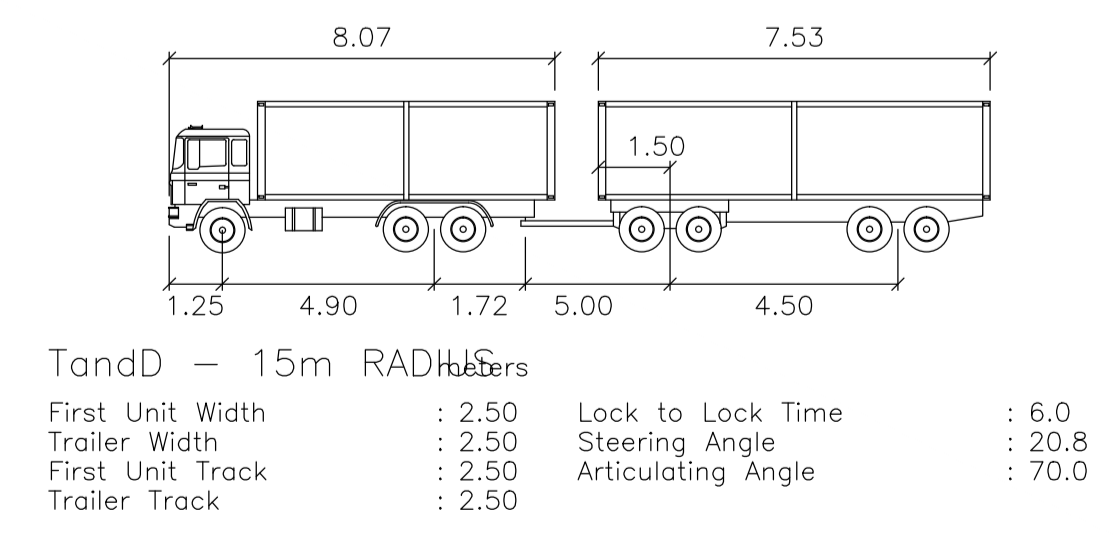

REV	BY	DATE	DESCRIPTION	APPD.
A	SS	16/08/21	INITIAL DRAFT	SL
COORDINATE SYSTEM:			HEIGHT DATUM:	SCALE:

DRAWN BY:	SS	PROJECT
DRW CHECK:	SL	
APPROVED:	SL	
IND REVIEW:	SL	

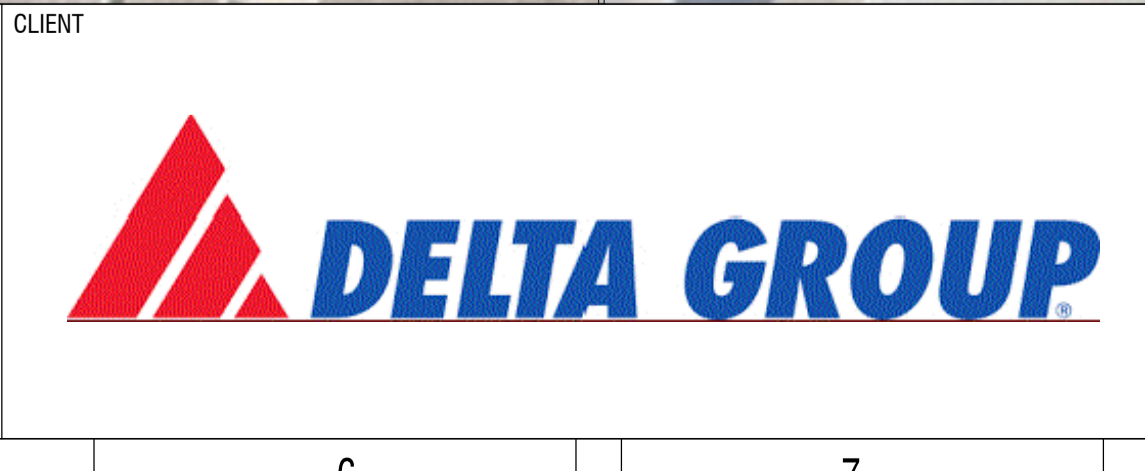



DELTA  
 PARAMATTA  
 SWEEP PATH ANALYSIS

DRAWING No:	PAR-SPA-03 to 06	
SHEET	1	OF 1
REVISION	A	



GENERAL NOTES  
 - 500MM VEHICLE BODY SHOWN WITH DASHED LINE  
 - DESIGN VEHICLE SWEEP PATH COMPLETED AT 5KPH  
 - ALL SWEEP PATHS COMPLETED ON SCALED AERIAL IMAGERY AND SHOULD BE VARIFIED ON SITE PRIOR TO HAULAGE OPERATIONS

BUILDING FACE   
 CONSTRUCTION HOARDING 

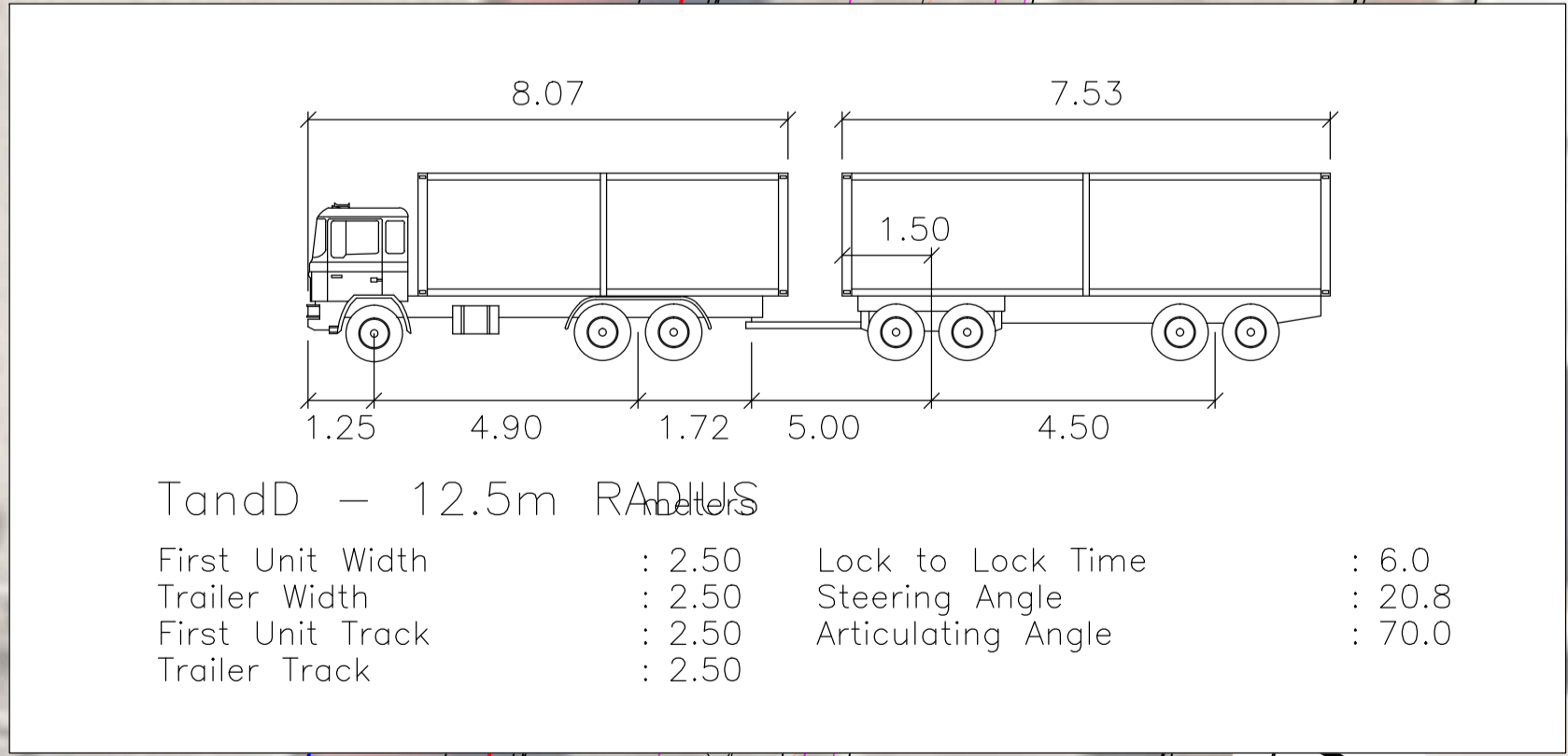
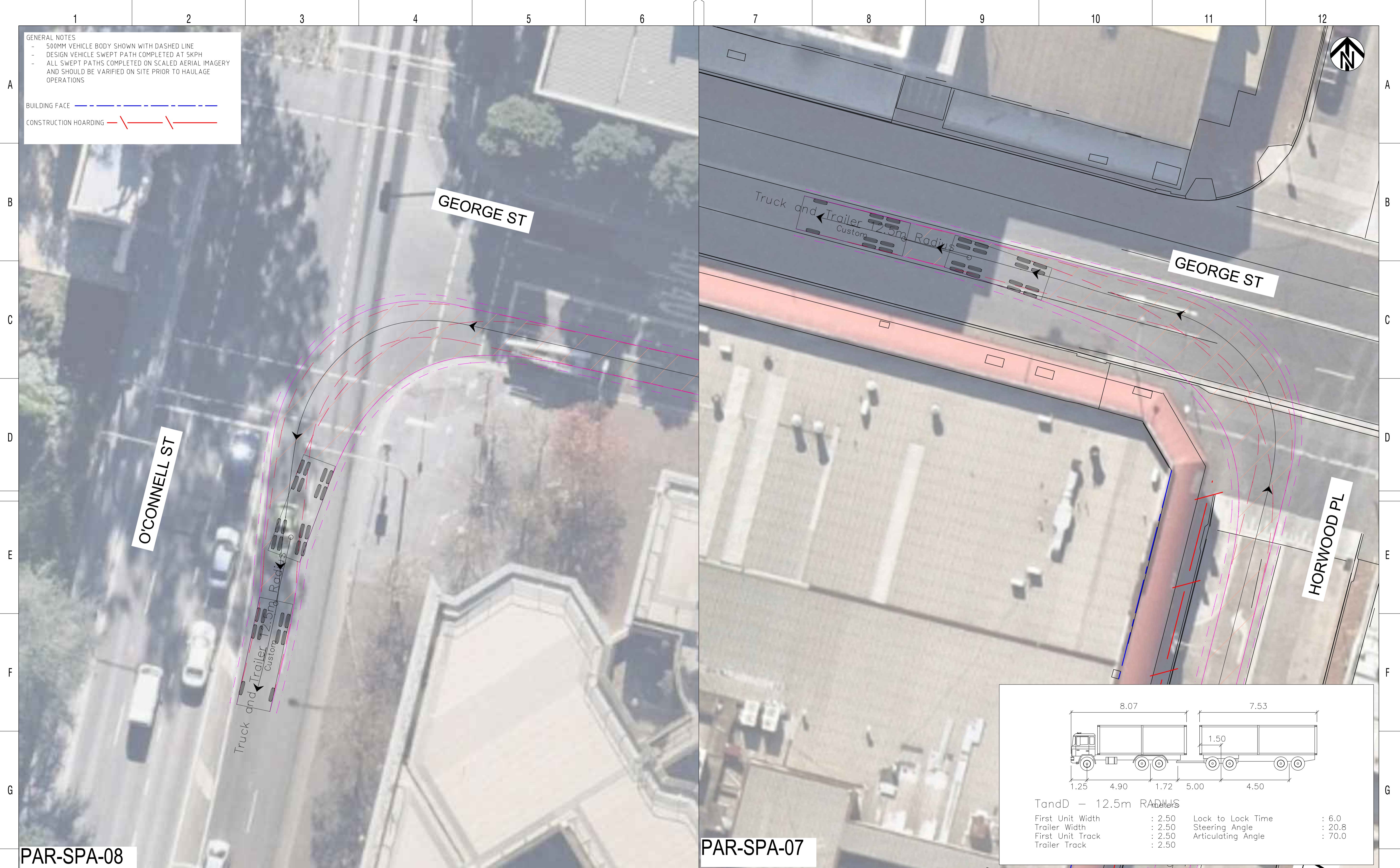

PAR-SPA-08

PAR-SPA-07

REV	BY	DATE	DESCRIPTION	APPD.
A		6/9/21	INITIAL DRAFT	SL
COORDINATE SYSTEM:			HEIGHT DATUM:	SCALE:

DRAWN BY:		PROJECT		CLIENT	
DRW CHECK:	SL				
APPROVED:	SL				
IND REVIEW:	SL				



DELTA  
 PARAMATTA SWEEP PATH ANALYSIS  
 12.5m RIGID VEHICLE

DRAWING No:	PAR-SPA-07&08	
SHEET	1	OF 1
REVISION	A	



## C. Written advice



7<sup>th</sup> October 2021

Dear Sir/Madam,

I am writing to outline my advice in relation to the local road use associated with the Parramatta Demolition works, specifically the works associated with the Delta Group demolition for the Sydney Metro West project. I have worked in road design, traffic consulting and road safety auditing for many years and am currently a Level 3 Road Safety Auditor in NSW.

I've reviewed the documentation titled 'Heavy Vehicle Local Road Report' provided by the project. The Ministerial Condition of Approval (MCoA D87) specifically requires inclusion of Swept Path Analysis, Demonstration that the use of the local roads will not compromise the safety of pedestrians and cyclists or traffic flow, road dilapidation requirements and measures to avoid local road use where practical and to avoid schools, aged care facilities and childcare facilities during their peak operational times.

The proposed additional roads include several local roads in the Central Business District area of Parramatta, and just north of the existing Parramatta train station.

The new local roads in question include;

- Phillip Street, between Wilde Avenue and Charles Street;
- Charles Street, between Phillip Street and George Street;
- George Street, between Charles Street and Smith Street; and
- Macquarie Street, between O'Connell Street and Horwood Place.

The swept path analysis provided are referenced from PAR-SPA-01 through to PAR-SPA-09. The majority have been tested and verified as suitable for the proposed movement. The swept path from Smith into George (PAR-SPA-02) does impact the kerb, it is noted however the route which would utilise this turn is not proposed to be included as part of the access requirements of the project.

The swept path analysis provided demonstrates heavy vehicles can utilise the proposed local roads without impact on opposing lanes or footpaths.

The use of the local roads proposed are expected to have moderate to high pedestrian traffic due to the proximity to the shopping and office areas of Parramatta. The document outlines additional measures to ensure trucks are easily seen by pedestrians, and that only forward movements will be permitted, or traffic control will be deployed. The areas within the new, proposed local road areas will typically have pedestrian interfaces managed with signalised crossings.

The proposed additional local roads don't appear to have any retirement, childcare or school facilities within the sections proposed for use.

The proposed use of the additional sections of local roads is expected to have limited to no adverse impact on sensitive facilities, cyclists or pedestrians and appear to meet the requirements outlined in MCoA D87.

Sincerely,

## D. Road Dilapidation Report Transmittal



## Document Transmittal

<b>Transmittal No:</b>	SMWSDDS-DLT-TX-000140
<b>Contract No:</b>	EWPC - Enabling Works - 00013/13014 Parramatta and Clyde
<b>Sub Contract:</b>	-- Select a Sub Contract --
<b>Date:</b>	02 October 2021, 11:25 AM

Issued	Name
By	[REDACTED]

Issued	Name
To	[REDACTED]
Cc	[REDACTED]

<b>Reason for Issue</b>	
<b>Subject</b>	SM 00013/13014 Parramatta & Clyde Enabling Works Road Dilapidation Report (Parramatta, Clyde & Westmead)
<p>[REDACTED]</p> <p><b>Contract No. SM 00013/13014 Parramatta &amp; Clyde Enabling Works Road Dilapidation Report (Parramatta, Clyde &amp; Westmead)</b></p> <p>Please find attached for your record completed Road Dilapidation undertaken for the Parramatta, Clyde and Westmead Sites for the proposed roads to be used by Heavy Vehicles not captured in the EIS that are local roads.</p> <p>Kind Regards,</p> <p>[REDACTED] Project Manager</p> <p>83 Bourke Road, Alexandria NSW 2015</p> <p>[REDACTED]</p>	

[Click here to download all Transmittal files.](#)

Item	Document No	Title	Rev	Sts	Type	Design Lots	Alt Doc No
1	<a href="#">SMWSDDS-DLT-1NL-SR-REP-000122</a>	Road Dilapidation Report (Parramatta, Clyde & Westmead)	01.01	INF	REP		